



**KERN & Sohn GmbH**

Ziegelei 1  
D-72336 Balingen  
E-Mail: [info@kern-sohn.com](mailto:info@kern-sohn.com)

Tel: +49-[0]7433- 9933-0  
Fax: +49-[0]7433-9933-149  
Internet: [www.kern-sohn.com](http://www.kern-sohn.com)

# Operating instructions

## Baby scale

### **KERN MBC-M**

Version 1.2  
01/2013  
GB



MBC-M-BA-e-1312



# KERN MBC-M

Version 1.2 01/2013

## Operating instructions Baby scale

### Contents

<b>1</b>	<b>Technical data</b> .....	<b>4</b>
<b>2</b>	<b>Declaration of conformity</b> .....	<b>5</b>
2.1	Explanation of the graphic symbols.....	5
<b>3</b>	<b>Appliance overview</b> .....	<b>7</b>
3.1	Overview of display.....	8
3.2	Keyboard overview.....	9
<b>4</b>	<b>Basic Information (General)</b> .....	<b>10</b>
4.1	Specific function.....	10
4.2	Proper use.....	10
4.3	Improper Use .....	11
4.4	Warranty .....	11
4.5	Monitoring of Test Resources.....	11
<b>5</b>	<b>Basic Safety Precautions</b> .....	<b>12</b>
5.1	Pay attention to the instructions in the Operation Manual .....	12
5.2	Personnel training .....	12
5.3	Preventing contamination .....	12
<b>6</b>	<b>Electromagnetic compatibility (EMC)</b> .....	<b>13</b>
6.1	General hints.....	13
6.2	Electromagnetic interferences .....	14
6.3	Electromagnetic noise immunity .....	15
6.3.1	Crucial features of performance .....	17
6.4	Minimum distances .....	17
<b>7</b>	<b>Transport and storage</b> .....	<b>18</b>
7.1	Testing upon acceptance .....	18
7.2	Packaging / return transport .....	18

<b>8</b>	<b>Unpacking, Setup and Commissioning</b> .....	<b>19</b>
8.1	Installation Site, Location of Use .....	19
8.2	Unpacking .....	19
8.3	Scope of delivery .....	20
8.4	Placing .....	20
8.5	Battery operation is possible by obtaining an optional battery power pack. ....	21
8.6	Mains connection .....	22
8.7	Initial Commissioning .....	22
<b>9</b>	<b>Operation</b> .....	<b>23</b>
9.1	Weighing .....	23
9.2	Taring .....	23
9.3	Hold function (Standstill function) .....	24
9.4	Feeding function (control of weight gain) .....	25
9.5	Show another decimal place (not verified value) .....	25
9.6	Use the optional size measurement device .....	26
<b>10</b>	<b>Menu</b> .....	<b>27</b>
10.1	Navigation in the menu .....	27
10.2	Menu overview .....	28
<b>11</b>	<b>Error messages</b> .....	<b>29</b>
<b>12</b>	<b>Service, maintenance, disposal</b> .....	<b>30</b>
12.1	Cleaning .....	30
12.2	Cleaning / disinfecting .....	30
12.3	Service, maintenance .....	30
12.4	Disposal .....	30
<b>13</b>	<b>Instant help</b> .....	<b>31</b>
<b>14</b>	<b>Verification</b> .....	<b>32</b>
14.1	Verification validity period (current status in G) .....	33
<b>15</b>	<b>Adjustment</b> .....	<b>34</b>



## 1 Technical data

KERN	MBC 15K2DM	MBC 20K10M
Weighing range (max)	6 kg / 15 kg	20 kg
Minimum load (Min)	40 g / 100 g	200 g
Readability (d)	2 g / 5 g	10 g
Verification value (e)	2 g / 5 g	10 g
Reproducibility	2 g / 5 g	10 g
Linearity $\pm$	2 g / 5 g	10 g
Display	LCD with 25mm high digits	
Recommended adjustment weight, not added (class)	15 kg (M1)	20 kg (M1)
Stabilization time (typical)	2 sec.	
Warm-up time	10 min	
Operating temperature	+ 0° C .... + 40° C	
Humidity of air	max. 80 % (not condensing)	
Input Voltage	220 V – 240 V AC, 50 Hz	
Auto Off	After “x” min adjustable without load change	
Dimensions fully mounted (W x D x H) mm	890 x 460 x 170 (incl. integrated height measuring device)	
Dimensions display unit (BxHxT) mm	200 x 125 x 58	
Baby weighing pan (WxDxH) mm	600 x 280 x 55	
Weight kg (net)	5.5	
Rechargeable battery operation	optional	
Verification according to 2009/23/EG	Medical grade III	
Medical product in accordance with 93/42/EEC	Category I with measuring function	
Height measuring rod, (optional)	Measuring range: 40 - 80 cm	

## 2 Declaration of conformity

Declaration of conformity: see separate document showing serial number of device

CE marking:

	93/42/EEC
	2009 / 23 / EG Non-automatic Weighing Instruments Directive

### 2.1 Explanation of the graphic symbols



This EC verification mark indicates that these scales are in conformity with EC Directive 2009 / 23 / EC for Non-Automatic Weighing Instruments. Weighing instruments bearing this mark are approved for medical purposes within the European Union.

**WF 132795**

Designation of the serial number of every device, applied at the device and on the packaging

(Number as an example)



2012-10

Identification of the manufacturing date of the medical product.

(Year and month here as example)



“Please note the accompanying documents“  
or “Please note operating instructions”



“Please note operating instructions”



“Please note operating instructions”



**Kern & Sohn GmbH**  
D-72336 Baligen, Germany  
www.kern-sohn.com

Identification of manufacturer of medical product including address



“Electro-medical appliance“  
with attachment for type B

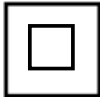

Device protection category II



Dispose of old appliances separately from your household waste!

Instead, take them to communal collection points.

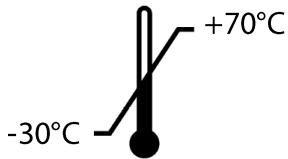

Temperature limit indicating the upper and the lower limit  
(storage temperature on packaging)  
(Temperature serving as an example)



Display of supply voltage for scales with polarity display.

---

### 3 Appliance overview



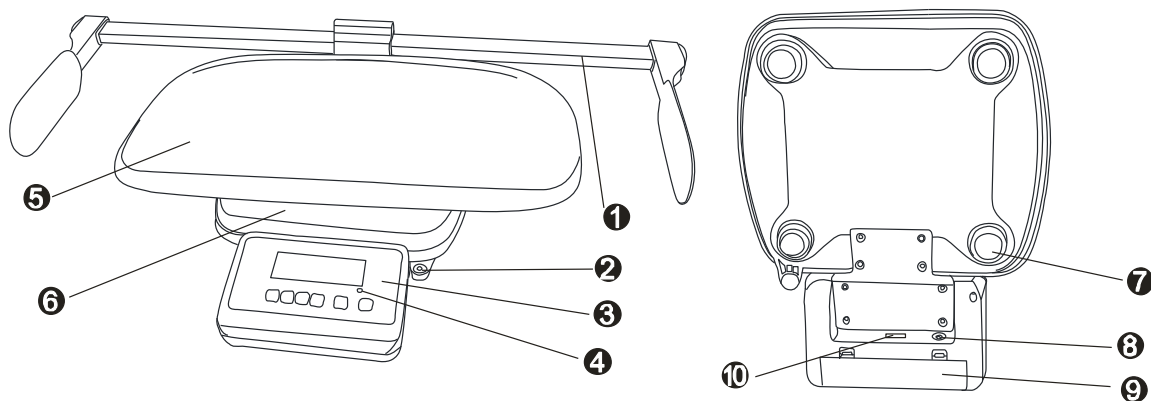

---

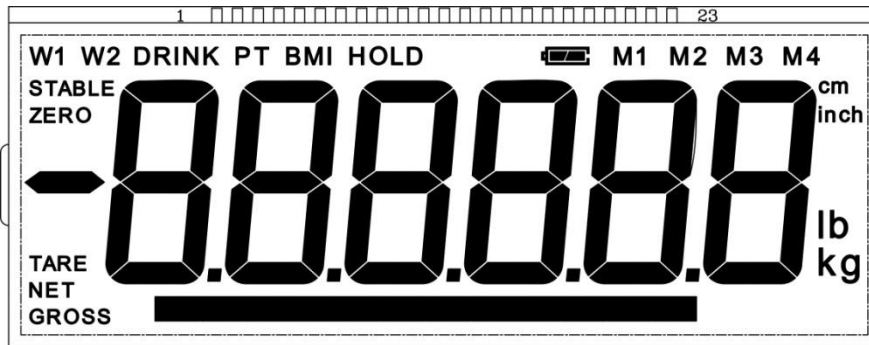

1. Height measuring rod (optional)
2. Bubble level
3. Display Unit
4. LED
5. Baby weighing pan
6. Weighing pan
7. Rubber feet (height adjustable)
8. Mains connection
9. Battery compartment
10. RS232

### 3.1 Overview of display









Display	Description	Description
<b>GROSS</b>	Gross weight display	Lights up during indication of the gross weight of the baby (after drinking)
<b>NET</b>	Net weight display	Lights up during indication of the net weight of the baby (before drinking) Illuminated after weighing scale was tared
<b>ZERO</b>	Zeroing display	Should the balance not display exactly zero despite empty scale pan, press the  button. Your balance will be set to zero after a short standby time.
<b>STABLE</b>	Stability display	Scales are in a steady state
<b>DRINK</b>	DRINK function	Is displayed with active drink function
<b>HOLD</b>	HOLD function	Is displayed with active hold function
	Rechargeable battery symbol	Lights when the voltage drops below the prescribed minimum.
		Lights when the rechargeable battery capacity is almost exhausted.
		Lights when the rechargeable battery is fully charged.



## 3.2 Keyboard overview

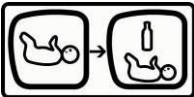

Key	Description	Function
	ON/OFF-switch	Turn on/off
	Zeroing key	Weighing scale will be reset to „0.0“ kg. <b>For numeric entry:</b> <ul style="list-style-type: none"> <li>Change decimal place</li> </ul>
	<b>HOLD</b> button	Hold function
	<b>TARE</b> button	Tare balance
	Feeding Function key	Differential weighing before and after the baby drinks
		The net weight of the baby will be shown: Before drinking  <b>In menu:</b> <ul style="list-style-type: none"> <li>Call up menu</li> <li>How to select menu items</li> </ul> <b>For numeric entry:</b> Edit numeric value
		The gross weight is displayed: After drinking  <b>In menu:</b> <ul style="list-style-type: none"> <li>⇒ Confirm selection</li> </ul> <b>For numeric entry:</b> <ul style="list-style-type: none"> <li>⇒ Confirm numerical value</li> </ul>

---

## 4 Basic Information (General)

---



Weighing instruments have to be verified for the purposes stated below in accordance with Directive 2009/23/EC. Article 1, paragraph 4. "Determination of mass in the practice of medicine that is, weighing patients for reasons of medical supervision during medical surveillance, examination and treatment."

### 4.1 Specific function

- Indication**
- Determining the body weight in the medical practice area.
  - Operated as "non-automatic weighing instrument" which means that you have to carefully put the baby in the centre of the weighing pan. Once a steady display value is shown, you can read the weight value.
- Contra-indication**
- No contraindication known

### 4.2 Proper use

These scales serve as a means of determining the weight of babies in medical treatment rooms. The scales are suitable for recognising, preventing and controlling illnesses.



Scales fitted with a serial interface may only be connected to appliances in compliance with Directive EN60601-1.



To prevent babies lying on the weighing pan from falling off the scale, they must be watched all the time. Please observe note on weighing pan!



### 4.3 Improper Use

Do not use these scales for dynamic weighing processes.

Do not leave permanent load on the weighing pan. This may damage the measuring system.

--

Impacts and overloading exceeding the stated maximum load (max) of the weighing plate, minus a possibly existing tare load, must be strictly avoided. This could cause damage to the balance.

Never operate balance in explosive environment. The serial version is not explosion protected. It should be noted that a flammable mixture of anaesthetics and oxygen or laughing gas may occur.

The structure of the balance may not be modified. This may lead to incorrect weighing results, safety-related faults and destruction of the balance.

The balance may only be used according to the described conditions. Other areas of use must be released by KERN in writing.

### 4.4 Warranty

Warranty claims shall be voided in case

- Our conditions in the operation manual are ignored
- The appliance is used outside the described uses
- The appliance is modified or opened
- mechanical damage and damage caused by media, liquids,
- natural wear and tear
- The appliance is improperly set up or incorrectly electrically connected
- The measuring system is overloaded
- Dropping the balance

### 4.5 Monitoring of Test Resources

In the framework of quality assurance the measuring-related weighing properties of the balance and, if applicable, the testing weight, must be checked regularly. The responsible user must define a suitable interval as well as type and scope of this test. Information is available on KERN's home page ([www.kern-sohn.com](http://www.kern-sohn.com)) with regard to the monitoring of balance test substances and the test weights required for this. In KERN's accredited DKD calibration laboratory test weights and balances may be calibrated (return to the national standard) fast and at moderate cost.



For balances with height measuring rods, we recommend a metrological examination of the accuracy of the height measuring rod, however, this is not mandatory as the determination of human body height involves rather large, intrinsic inaccuracies.

---

## 5 Basic Safety Precautions

---

### 5.1 Pay attention to the instructions in the Operation Manual

	<ul style="list-style-type: none"><li>⇒ Carefully read this operation manual before setup and commissioning, even if you are already familiar with KERN balances.</li><li>⇒ All language versions contain a non-binding translation. The original German is binding.</li></ul>	
-----------------------------------------------------------------------------------	------------------------------------------------------------------------------------------------------------------------------------------------------------------------------------------------------------------------------------------------------------------------------------	-------------------------------------------------------------------------------------

### 5.2 Personnel training

The medical staff must apply and follow the operating instructions for proper use and care of the product.

### 5.3 Preventing contamination

To prevent cross-contamination (fungal skin infections, ...), clean the baby weighing pan or weighing platform every time after weighing.

Recommendation: after a weighing procedure that could potentially result in contamination (e. g. after weighing that involves direct skin contact).

---

## 6 Electromagnetic compatibility (EMC)

---

### 6.1 General hints



The installation and use of this baby scale MBC-M requires special precautionary measures as outlined in the EMC information below.

This device complies with the limits set for medical electrical devices of group 1, class B (as per EN 60601-1-2).

Electromagnetic compatibility (EMC) describes a device's ability to perform reliably within an electromagnetic environment without causing inadmissible electromagnetic interference at the same time. Amongst other things, such disturbances may be emitted by connecting cables or the air.

Inadmissible disturbances from the environment may result in incorrect displays, inaccurate measured values or incorrect behaviour of the medical device. By the same token the medical device may in some cases cause such disturbances in other devices. To eliminate problems of that kind, we recommend you to take one or several of the measures listed below:

- Change the alignment or distance of the device to the source of EMI.
- Install or use the baby scale MBC-M at a different location.
- Connect the baby scale MBC-M to a different power source.
- For further questions please contact our customer services.

Disturbances may be caused by improper modification or add-ons to the device or not recommended accessories (such as power units or connecting cables). The manufacturer will not be responsible for these. Modifications may also result in a loss of authorisation relating to the use of the device.



Devices emitting high frequency signals (mobile telephones, radio transmitters, radio receivers) may cause interference in the medical device. For that reason do not use them near the medical device. Chapter 6.4 contains details about recommended minimum distances.

## 6.2 Electromagnetic interferences

<b>Guidelines and manufacturer's declaration – electromagnetic interferences</b>		
The baby scale MBC-M is designed for use in an electromagnetic environment that meets the requirements stated below. The customer or user of the medical electrical device must ensure that operation takes place in such an environment.		
<b>Emitted interference measurements</b>	<b>Conformity</b>	<b>Electromagnetic environment - guideline</b>
HF emissions as per CISPR 11 / EN 55011	Group 1	The baby scale MBC-M uses HF energy merely for its internal working. Its HF emission therefore is very low and it is highly unlikely to interfere with adjacent electronic devices.
HF emissions as per CISPR 11 / EN 55011	Class B	The baby scale MBC-M is designed for use in all equipment including those in living areas and those connected directly to the public power grid that also supplies buildings used for living purposes.
Emission of harmonics as per IEC 61000-3-2	Class A	
Emission of voltage fluctuations / flicker as per IEC 61000-3-3	Conforms with	

Do not put the baby scale MBC-M directly next to other devices and do not stack it with other devices. If this type of operation is necessary, observe the baby scale MBC-M to ensure normal operation in such an arrangement.

### 6.3 Electromagnetic noise immunity

<b>Guidelines and manufacturer's declaration - electromagnetic noise immunity</b>			
The baby scale MBC-M is designed for use in an electromagnetic environment that meets the requirements stated below. The customer or user of the medical electrical device must ensure that operation takes place in such an environment.			
<b>Noise immunity tests</b>	<b>IEC 60601 test level</b>	<b>Conformity</b>	<b>Electromagnetic environment - guideline</b>
Discharge static electricity (DSE) as per IEC 61000-4-2	± 6 kV contact discharge ± 8 kV air discharge	± 6 kV ± 8 kV	Floors should be made of wood or concrete or tiled with ceramic tiles. If floors are covered with synthetic material, relative air humidity must be at least 30%.
Fast transient electrical disturbances / bursts as per IEC 61000-4-4	± 2 kV for power lines ± 1 kV for input and output lines	± 2 kV ± 1 kV	The quality of the supply voltage should match that of the typical business or hospital environment.
Impulse voltages / surges as per IEC 61000-4-5	± 1 kV voltage Live wire - live wire ± 2 kV voltage Live wire - earth	± 1 kV Inapplicable	The quality of the supply voltage should match that of the typical business or hospital environment.
Voltage dips, short-term disruptions and fluctuations in supply voltage as per IEC 61000-4-11	< 5 % $U_T$ (> 95 % dip of $U_T$ ) for ½ period  40 % $U_T$ (> 60 % dip of $U_T$ ) for 5 periods  70 % $U_T$ (> 30 % dip of $U_T$ ) for 25 periods  < 5 % $U_T$ (> 95 % dip of $U_T$ ) for 5 s	Compliance with requirements under all postulated conditions  Controlled switch off Return to undisturbed situation after user intervention.	The quality of the supply voltage should match that of the typical business or hospital environment. Where the user of the baby scale MBC-M demands continuous operation even during disruptions to the power supply, we recommend powering the baby scale MBC-M by no-break power supply or battery.
Magnetic field for supply frequency (50/60 Hz) as per IEC 61000-4-8	3 A/m	3 A/m 50/60 Hz	Magnetic fields for the supply frequency should match the typical values found in the particular business or hospital environment.
<b>NOTE</b> $U_T$ equals AC line voltage prior to application of test level.			

## Guidelines and manufacturer's declaration - electromagnetic noise immunity

The baby scale MBC-M is designed for use in an electromagnetic environment that meets the requirements stated below. The customer or user of the medical electrical device must ensure that operation takes place in such an environment.

Noise immunity tests	IEC 60601 test level	Conformity	Electromagnetic environment - guideline
Conducted HF disturbance variables as per IEC 61000-4-6	3 $V_{rms}$ 150 kHz to 80 MHz	3 V	<p>Do not use portable or mobile radio sets nearer to the baby scale MBC-M or its wires than the distance recommended as safety distance which is calculated according to the equation relevant for its transmission frequency.</p> <p>Recommended safety distance:  <math>d = 1.2\sqrt{P}</math>  <math>d = 1.2\sqrt{P}</math>                      for 80 MHz to 800 MHz  <math>d = 2.3\sqrt{P}</math>                      for 800 MHz to 2.5 GHz</p> <p>Use P as rated capacity of radio transmitter in Watt (W) as per details given by the radio transmitter manufacturer and d as recommended safety distance in metres (m).</p> <p>The field intensity of stationary radio transmitters should for all frequencies be lower according to an in situ<sup>a</sup> examination than the conformity level.<sup>b</sup></p> <p>Interference may occur near devices bearing the symbol below.</p>
Emitted HF disturbance variables as per IEC 61000-4-3	3 $V_{rms}$ 80 MHz to 2.5 GHz	3 V/m	



NOTE 1 Higher frequency range applies to 80 MHz and 800 MHz.

NOTE 2 These guidelines may not be applicable in all cases.  
The spread of electromagnetic variables is influenced by absorption and reflections in buildings, objects and humans.

<sup>a</sup> The field intensity of stationary radio transmitters such as base stations of wireless telephones and mobile radio sets, amateur radio stations, AM and FM radio and television stations cannot be reliably predicted in advance. To determine the electromagnetic environment in respect of stationary transmitters, you should consider a study of electromagnetic phenomena at the location. If the measured field intensity at the location where the baby scale MBC-M is to be used exceeds the conformity level above, you should observe the baby scale MBC-M in order to ensure normal operation. If you observe unusual features of performance you may have to take additional measures such as a change in alignment or a different location for the baby scale MBC-M.

<sup>b</sup> For a frequency range of 150 kHz to 80 MHz field intensity should be less than 3 V/m.



### 6.3.1 Crucial features of performance

Note:



The baby scale MBC-M does not have any crucial features of performance as per IEC 60601-1. The system may be subject to interference by other devices even if these devices conform to current emission requirements as per CISPR.

### 6.4 Minimum distances

<b>Recommended safety distances between portable and mobile HF telecommunication devices and the medical device</b>			
The baby scale MBC-M is designed for use in an electromagnetic environment in which HF disturbance variables are controlled. The customer or user of the medical electrical device can help avoiding electromagnetic disturbances by keeping the minimum distance between portable and mobile HF telecommunication devices (transmitters) and the medical device – depending on the output performance of the communication device, as stated below.			
Rated capacity of transmitter W	The safety distance depends on the transmission frequency m		
	150 kHz to 80 MHz $d = 1.2\sqrt{P}$	80 MHz to 800 MHz $d = 1.2\sqrt{P}$	800 MHz to 2.5 GHz $d = 2.3\sqrt{P}$
0.01	0.12	0.12	0.23
0.1	0.38	0.38	0.73
1	1.20	1.20	2.30
10	3.80	3.80	7.30
100	12.00	12.00	23.00
For transmitters with a maximum rated capacity not stated in the table above you can calculate the recommended safety distance in metres (m) yourself by using the equation belonging to each column, whereby P equals the maximum rated capacity of the transmitter in Watt (W) as per details provided by the transmitter manufacturer.			
NOTE 1	Higher frequency range applies to 80 MHz and 800 MHz.		
NOTE 2	These guidelines may not be applicable in all cases. The spread of electromagnetic variables is influenced by absorption and reflections in buildings, objects and humans.		

---

## 7 Transport and storage

---

### 7.1 Testing upon acceptance

When receiving the appliance, please check packaging immediately, and the appliance itself when unpacking for possible visible damage.

### 7.2 Packaging / return transport



- ⇒ Keep all parts of the original packaging for a possibly required return.
- ⇒ Only use original packaging for returning.
- ⇒ Prior to dispatch disconnect all cables and remove loose/mobile parts.
- ⇒ Reattach possibly supplied transport securing devices.
- ⇒ Secure all parts such as the weighing pan, power unit etc. against shifting and damage.

---

## 8 Unpacking, Setup and Commissioning

---

### 8.1 Installation Site, Location of Use

The balances are designed in a way that reliable weighing results are achieved in common conditions of use. You will work accurately and fast, if you select the right location for your balance.

**On the installation site observe the following:**

- Place scales on a stable, even surface
- Avoid extreme heat as well as temperature fluctuation caused by installing next to a radiator or in the direct sunlight;
- Protect the balance against direct draughts due to open windows and doors;
- Avoid jarring during weighing;
- Protect the balance against high humidity, vapours and dust;
- Do not expose the device to extreme dampness for longer periods of time. Non-permitted condensation (condensation of air humidity on the appliance) may occur if a cold appliance is taken to a considerably warmer environment. In this case, acclimatize the disconnected appliance for ca. 2 hours at room temperature.
- Avoid static charge of the balance and of the person to be weighed.
- Avoid contact with water.

Major display deviations (incorrect weighing results) may be experienced should electromagnetic fields (e.g. due to mobile phones or radio equipment), static electricity accumulations or instable power supply occur. In that case, the location must be changed.

### 8.2 Unpacking

Take the balance out of their packaging and place it at the intended position. When using the power pack, ensure that the power cable does not produce a risk of stumbling.

### 8.3 Scope of delivery

- Balance
- Power pack unit (EN 60601-1 attestation of conformity)
- Operating instructions

### 8.4 Placing

Carefully remove the balance from the packaging, remove plastic cover and setup balance at the intended workstation.



**Make sure that all transport locking devices are removed**

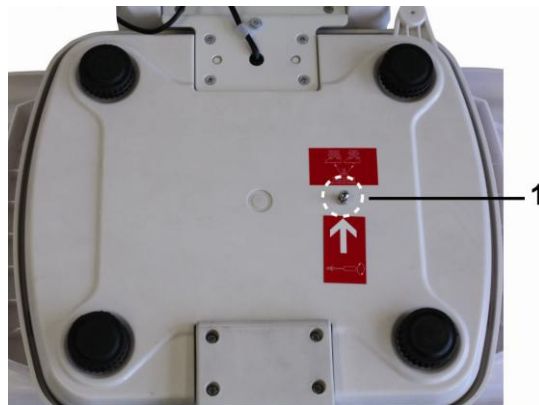

**To loosen** the transport guard screw out transport screw [1] anticlockwise.

**For transportation** carefully screw-in transport screw clockwise till to the stopper and then fix it using locknut.

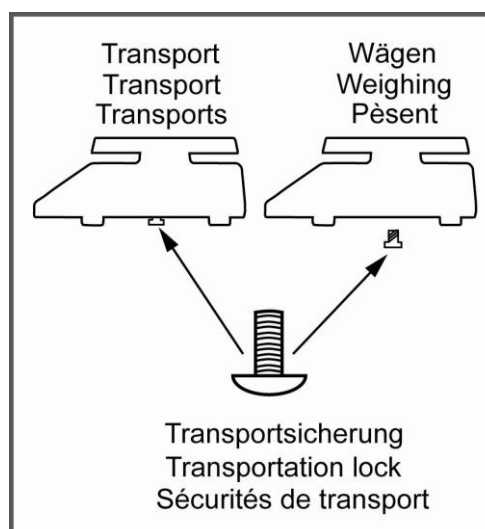

## Levelling

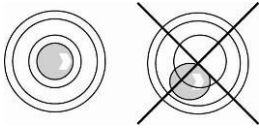



Level balance with foot screws until the air bubble of the water balance is in the prescribed circle.

### 8.5 Battery operation is possible by obtaining an optional battery power pack.



Open the battery compartment cover (1) at the base of the display unit and insert the rechargeable battery pack. Charge the battery for at least 12 hours before initial use. The appearance of the symbol  in the weight display indicates that the battery packs is almost exhausted. The weighing scale will remain ready for operation for a few more minutes before switching off in order to save battery. Load rechargeable battery.

-  Voltage has dropped below prescribed minimum.
-  Rechargeable battery very low.
-  Rechargeable battery completely reloaded

If the balance is not used for a longer time, take out the battery pack and store it separately. Leaking liquid could damage the balance.

## 8.6 Mains connection

Power is supplied by the external power unit which also serves to isolate the mains supply from the scale. The stated voltage value must be the same as the local voltage.

Only approved genuine KERN power supply units may be used in compliance with Directive EN 60601-1.

The small sticker attached to the side of the display unit indicates the power port:

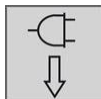

The LED remains illuminated as long as the weighing scale remains connected to the mains.

The LED display provides information about the battery's charging status.

**Green:** battery is fully charged

**Blue:** battery is charging

## 8.7 Initial Commissioning

In order to obtain exact results with the electronic balances, your balance must have reached the operating temperature (see warming up time chap. During this warming up time the balance must be connected to the power supply (mains, accumulator or battery) and be switched on.

The accuracy of the balance depends on the local acceleration of gravity.

The value of gravity acceleration is shown on the type plate.

## 9 Operation

### 9.1 Weighing



- ⇒ Start balance by pressing .  
The balance will carry out a self-test  
The scales are ready for operation as soon as the weight display for "0.0kg" has appeared.



- However, you can reset the weighing scale to zero by pressing the  key.

- ⇒ Put the baby in the centre of the weighing pan.  
⇒ Wait for stability display "STABLE", then read the weighing result.



- If the baby is heavier than the max. weighing range, the display shows "oL" (overload) and a beep sounds.

### 9.2 Taring

The tare weight of any preloads can be deducted by pressing a button so that the actual weight of the baby is displayed in subsequent weighings.

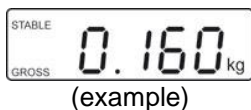

- ⇒ Put object (such as towel or padding) on the weighing pan.  
⇒ Wait until stability display „STABLE“ appears



- ⇒ Press , the zero display appears.



- ⇒ Put baby on the weighing pan.  
Wait until the stability display „STABLE“ appears, then read the weighing result. „NET“ is shown at the bottom on the left.



- When the balance is unloaded the saved taring value is displayed with negative sign.
- To delete the stored tare value, release scales and press .

### 9.3 Hold function (Standstill function)

The balance has an integrated standstill function (mean value calculation). This allows one to weigh the baby exactly, even if it is not restful in the weighing pan.

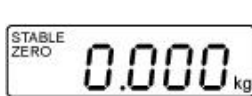

- ⇒ Start balance by pressing . Wait for stability display „STABLE“ to appear.

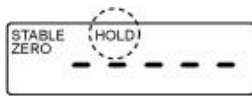

- ⇒ Press  button, „-----“, is displayed. In addition the „HOLD“ symbol appears.



(Beispiel)

- ⇒ Put the baby in the centre of the weighing pan. The weight of the baby will be displayed and „frozen“.
- ⇒ After unloading the balance, the weighing value remains displayed for approx. 10 seconds, than the balance returns automatically into the weighing mode. The „HOLD“ symbol disappears.







## 9.4 Feeding function (control of weight gain)

The baby's weight can be saved before feeding. Then the weight gain can be calculated by pressing a button.



⇒ Start balance by pressing . Stability display await "STABLE"



⇒ Place the baby on the weighing pan center before feeding.  
⇒ After the stability display shows "STABLE", press . The weight of the baby is recorded and stored. Display "DRINK" lights up.



⇒ Take the baby from the weighing pan.

⇒ Place the baby on the scale pan after feeding.



⇒ Press , the difference between the weight and the value before and after breastfeeding is displayed.



By pressing the  button several times, the balance returns to the normal weighing mode.

## 9.5 Show another decimal place (not verified value)

Press  and hold for about 2 s whilst weighed result is being shown. The second decimal place will be shown for approx. 5 s.

## 9.6 Use the optional size measurement device

The scale has the ability to determine not only the weight but also the body height using the optional height measuring rod.

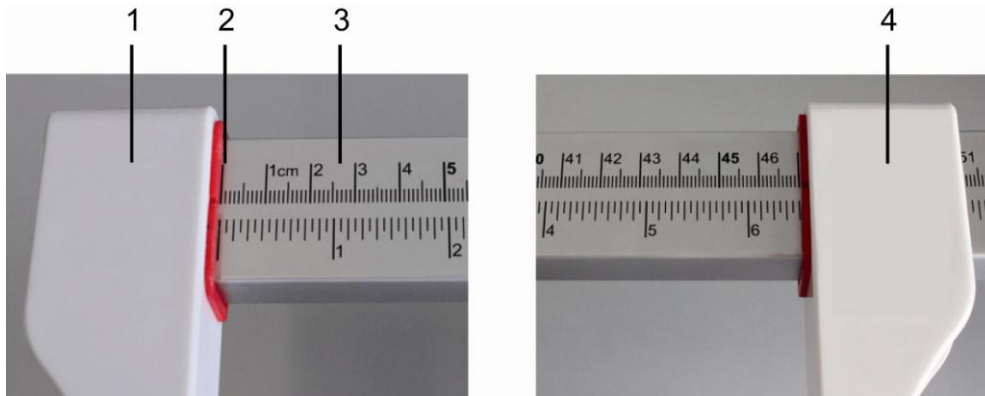

For this purpose proceed as follows:

- ⇒ Put the head stopper (left) (1) to zero (2)
- ⇒ Put the baby in the centre of the weighing pan.
- ⇒ Move the height measuring rod (3) carefully to the right until the head stopper (3) gently touches the baby's head
- ⇒ With the right hand push the foot stopper (right) (4) carefully to the soles of the baby
- ⇒ On the scale read the baby's size.



For further information (for example, installation), refer to the instruction manual that comes with the height measurement.

---

## 10 Menu

---



Access to service menu „tCH“ is locked in verified balances. To disable the access lock, destroy the seal and actuate the adjustment switch. For position of adjustment switch, see chap. 13.

**Attention:**

After destruction of the seal the weighing system must be re-verified by an authorised agency and a new verification wire/seal mark fitted before it can be reused for applications subject to verification.

### 10.1 Navigation in the menu

#### Call up menu



⇒ Turn on the scale during the self-test press , the first function **[F1 OFF]** is displayed.

#### Select function

⇒ With help of , the individual functions can be selected one after the other.

#### Change settings

⇒ Confirm selected function by . The current setting will be displayed.



⇒ Select the desired setting with  and press  to confirm or  to reject, the balance returns to the menu.

#### Exit menu/

#### Return to weighing mode

⇒ Press , the balance will return to weighing mode.

## 10.2 Menu overview

Function	Settings	Description
<b>F1 oFF</b> <b>Automatic cutout</b> <b>Auto Off</b>	oFF 0*	Automatic shutdown off
	oFF 3	Automatic shutdown after 3 sec
	oFF 5	Automatic shutdown after 5 sec
	oFF 15	Automatic shutdown after 15 sec
	oFF 30	Automatic shutdown after 30 sec
<b>F2 bk</b> <b>Background illumination of display</b>	bl on	Back lighting for display on
	bl oFF	Display background illumination off
	bl AU*	Backlighting for display will come on automatically as soon as the weighing scale is operated.
<b>F3 Str</b> <b>Subsequent tare value locked in devices with type approval certificate.</b>	Str on	Following tare ON
	Str oFF*	Following tare OFF
<b>tCH</b> <b>Service menu</b>	Pin	If display shows "Pin" adjust switch. Then press  ,  ,  subsequently.
<b>P1 Spd</b> <b>Display speed</b>	15*	Not documented
	30	
	60	
	7.5	
<b>P2 CAL</b>	Adjustment, see chap. 14	
<b>P3 Pro</b>	tri	Not documented
	CoUnt	Not documented
	rESEt	Reset weighing scale to factory setting
	SEtGrA	Not documented

\* default setting

---

## 11 Error messages

---

### Display

### Description

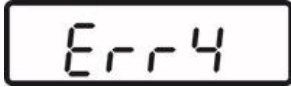

#### Zero range exceeded

(on start-up or when pressing the  key)

- Load on weighing pan
- Excess load, during zero setting of weighing scale
- Incorrect adjusting process
- Fault on load cell



#### Value outside the A/D changer range

- Damaged weighing cell
- Damaged electronics

Should other error messages occur, switch balance off and then on again. If the error message remains inform manufacturer.

---

## 12 Service, maintenance, disposal

---

### 12.1 Cleaning



Before any maintenance, cleaning and repair work disconnect the appliance from the operating voltage.

### 12.2 Cleaning / disinfecting

Clean weighing pan and housing with a household cleaner or a commercial disinfectant. Please follow manufacturer's instructions.

Do not use abrasive or aggressive cleaners such as spirits or alcohol or similar as they might damage the high-quality surface.

The prevention of cross-contamination (fungal skin infections,.....) requires regular cleaning of the weighing pan. Recommendation: after a weighing procedure that could potentially result in contamination (e. g. after weighing that involves direct skin contact).



Do not spray disinfectants onto appliance.

Make sure that disinfectant does not penetrate the interior of the appliance.

Remove dirt immediately.

### 12.3 Service, maintenance

The appliance may only be opened by trained service technicians who are authorized by KERN.

Disconnect the scales before opening.

### 12.4 Disposal

Disposal of packaging and appliance must be carried out by operator according to valid national or regional law of the location where the appliance is used.

---

## 13 Instant help

---

In case of a fault in the program sequence, the balance should be shortly switched off. The weighing process must then be restarted from the beginning.

### Failure:

### Possible causes:

The displayed weight does not glow.

- The balance is not switched on.
- The mains supply connection has been interrupted (mains cable not plugged in/faulty).
- Power supply interrupted.
- Rechargeable battery inserted incorrectly or empty
- No rechargeable battery inserted

The displayed weight is permanently changing

- Draught/air movement
- Table/floor vibrations
- The weighing pan is in contact with foreign bodies or is not correctly positioned.
- Electromagnetic fields / static charging (choose different location/switch off interfering device if possible)

The weighing result is obviously incorrect

- The display of the balance is not at zero.
- Adjustment is no longer correct.
- Great fluctuations in temperature.
- The balance is on an uneven surface.
- Electromagnetic fields / static charging (choose different location/switch off interfering device if possible)

Should other error messages occur, switch balance off and then on again. If the error message remains inform manufacturer.

---

## 14 Verification

---

### General introduction:

According to EU directive 2009/23/EC balances must be officially verified if they are used as follows (legally controlled area):

- a) For commercial transactions if the price of goods is determined by weighing.
- b) For the production of medicines in pharmacies as well as for analyses in the medical and pharmaceutical laboratory.
- c) For official purposes
- d) For manufacturing final packages

In cases of doubt, please contact your local trade in standard.

### Verification notes:

An EU type approval exists for balances described in their technical data as verifiable. If a balance is used where obligation to verify exists as described above, it must be verified and re-verified at regular intervals.

Re-verification of a balance is carried out according to the respective national regulations. For verification validity period, s. chap. 16.1.

The legal regulation of the country where the balance is used must be observed!

### **i** Verification of the balance is invalid without the seal.

The seal marks attached on balances with type approval point out that the balance may only be opened and serviced by trained and authorised specialist staff. If the seal mark is destroyed, verification loses its validity. Please observe all national laws and legal regulations. In Germany a re-verification will be necessary.

### Balances with obligation to verify must be taken out of operation if:

- **The weighing result of the balance is outside the error limit.** Therefore, in regular intervals load balance with known test weight (ca. 1/3 of the max. load) and compare with displayed value.
- **The reverification deadline has been exceeded.**



**Position adjustment switch and seals:**

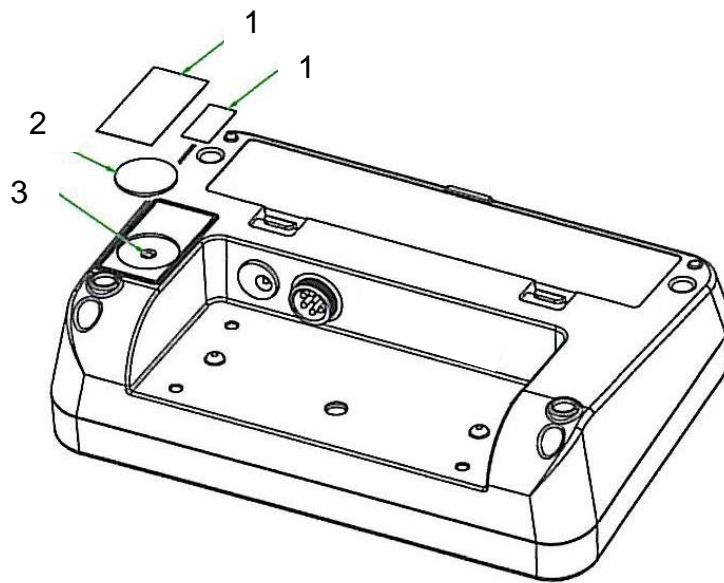

1. Self-destroying seal mark
2. Cover
3. Adjustment switch

**14.1 Verification validity period (current status in G)**

Personal scales (including chair and wheelchair scales) in hospitals	4 year
Personal scales, when not located in hospitals (for example, doctor's offices and nursing homes)	unlimited
Baby weighing scales and mechanical birth weight scales	4 year
Bed scales	2 year
Scales in dialysis stations	unlimited

Rehab clinics and health authorities are treated as hospitals.  
(4 years of verification validity)

Not treated as hospitals (verification validity not limited) are dialysis stations, nursing homes and doctor's surgeries.

(Details derived from: „Information by the verification authority, weighing scales applied in medical use“)

---

## 15 Adjustment

---

As the acceleration value due to gravity is not the same at every location on earth, each display unit with connected weighing plate must be coordinated - in compliance with the underlying physical weighing principle - to the existing acceleration due to gravity at its place of location (only if the weighing system has not already been adjusted to the location in the factory). This adjustment process must be carried out for the first commissioning, after each change of location as well as in case of fluctuating environment temperature. To receive accurate measuring values it is also recommended to adjust the display unit periodically in weighing operation.



- Prepare the required adjustment weight. The adjustment weight to be applied depends on the capacity of a weighing scale, see chap. 1. Carry out adjustment as closely as possible to admissible maximum load of weighing scale. Information about test weights you will find in the internet under <http://www.kern-sohn.com>
- Observe stable environmental conditions. For warm-up time required for stabilisation see chpt 1.

















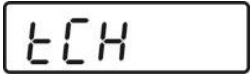





Access to service menu „tCH“ is locked in verified balances.

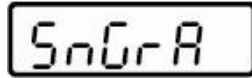

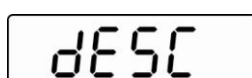





To disable the access lock, destroy the seal and actuate the adjustment switch. Position of the adjustment switch see chap. 13.

**Attention:**

After destruction of the seal the weighing system must be re-verified by an authorised agency and a new verification wire/seal mark fitted before it can be reused for applications subject to verification.

**Procedure:**

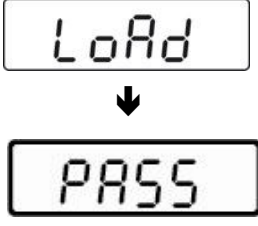
 <p>↓</p> 	<p>⇒ Turn on the scale during the self-test press , the first function [F1 OFF] is displayed.</p> <p>⇒ Press  repeatedly until "t CH" is displayed.</p>
	<p>⇒ Press , [Pin] is displayed</p>
	<p><b>Operate adjustment switch; for position see chap.13</b></p> <p>Press ,  and  subsequently, [P1 SPd] will appear</p>
 <p>↓</p> 	<p>⇒ Press , „P2 CAL“ will be displayed</p>
 <p>↕</p>  <p>↓</p> 	<p>⇒ Press , the currently set balance type is displayed.</p> <p>SnGrA = single range balance dUArG = dual range balance</p> <p>⇒ To change select scale type with  and confirm with , [dESC] appears.</p>
	<p>⇒ Press  repeatedly until „CAL“ will be displayed.</p> <p>⇒ Confirm with , [UnloAd] appears</p>

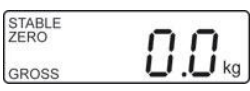
	<p>⇒ Ensure that there are no objects on the weighing pan.</p> <p>⇒ Wait for stability display "STABLE", then confirm with </p>
 <p>(example)</p>	<p>⇒ The size of the currently set adjustment weight is displayed, the active site flashes.</p> <p>If required, select with  the digit to be altered and change the digit with .</p> <p>Confirm with , <b>[LoAd]</b> appears</p>
	<p>⇒ Put the required adjustment weight carefully in the centre of the weighing pan.</p> <p>⇒ Wait until stability display „STABLE“ appears</p> <p>⇒ Confirm with  <b>[PASS]</b> is displayed.</p>
	<p>After the adjustment the balance will carry out a self-test. Remove adjusting weight <b>during</b> selftest, balance will return into weighing mode automatically.</p> <p>An adjusting error or incorrect adjusting weight will be indicated by the error message; repeat adjustment procedure.</p> <p>An adjusting error or incorrect adjustment weight will generate an error message („Err 4“), repeat the adjustment process.</p>