



Limit/Enclosed

GENERAL INFORMATION

The GLS series is specifically designed for world-wide applications and is supported by Honeywell global resources for sales and after sales service.

Over 300 versions designed to the newest IEC standard are available and include a wide range of EN50041 and EN50047 type switches. Miniature EN50047 limit switches are available in metal and double insulated enclosures and a metal enclosed 3-cable entry version (EN50047 mounting compatible) is also offered. The larger EN50041 switches include metal enclosed standard and plug-in versions.

Standard GLS switch circuit variations include 2 and 4-circuit snap action versions with forced disconnect mechanism and two 2-circuit slow make and break versions. Two-circuit bifurcated contact versions allow direct PLC interface. Plug-in GLS switch types feature a 2-circuit snap action switch with forced disconnect.

GLS includes features to make quick installation easier and safer. Screwdriver guides, wire guides and finger guard protection are provided.

Customers will benefit from Honeywell's vast experience in serving world industries over many years. To minimize plant downtime and reduced maintenance costs, the GLS series includes plug-in and indicator switches with single or twin LEDs.

All EN50041 products feature modular constructions. Head, body or basic switch components are available separately as replacement parts. GLS allows end user maintenance inventories and costs to be contained. Most GLS versions are interchangeable with almost all other makes of EN50041/47 switches.

TYPICAL APPLICATIONS

- Machine tools: metal fabrication equipment, presses, transfer lines and special machinery
- Material handling equipment: conveyors, elevators, cranes and hoists
- Packaging machinery and process equipment
- Textile machinery
- Construction machinery and equipment, vehicles and lift trucks

FEATURES

- Designed to the new IEC standard for world-wide applications
- EN50041 metal standard and plug-in versions
- EN50047 metal and double insulated versions
- EN50047 mounting compatible, 3-cable entry metal versions
- UL, CSA, and CE
- Sealing up to IP 67/NEMA 4
- International conduit sizes
- Snap action and slow action mechanism with forced disconnect
- Direct PLC interface compatible (two circuit)
- Galvanically isolated contacts (two circuit)
- Modular construction reduces maintenance parts costs
- Design for ease of installation
- Five basic switch versions
- Wide choice of actuators

Limit and Enclosed Switches

Standards/How to read and understand the bar chart information

Standards

IEC 947-1 explains the general rules relating to **Low-voltage switchgear and controlgear**. The purpose of this standard is to harmonize as much as possible the product performance and test requirements for equipment where the rated voltage does not exceed 1,000 VAC or 1,500 VDC.

IEC 947-5-1 is part 5 of the general rules which relates to **Control-circuit devices and switching elements**. Also within this part there is a section which considers **Special Requirements For Control Switches With Positive Opening Operation**. Any control switch which has this positive opening operation and conforms to these special requirements will be marked on the outside of the product with this symbol:



The Contact Element Form defines the configuration of the contacts and the number of contacts within the switch. e.g.

- Form Za – both contact elements have the same polarity.
- Form Zb – the two contact elements are electrically separated.

The **Utilization Category** defines the type of current carried (AC) Alternating current, (DC) Direct current and the typical application in which the switch is used e.g.

- AC15 – Control of Electromagnetic Loads (less than 72VA)
- DC13 – Control of electromagnets.

The contact rating **Designation** relates to the utilization categories and defines the conventional thermal current Ith (A), rated operational current Ie (A) at rated operational voltages Ue and the VA rating e.g.

- A600 – The “A” denotes the maximum VA rating (AC) and the “600” denotes the maximum rated (AC) voltage.
- Q300 – The “Q” denotes the maximum VA rating (DC) and the “300” denotes the maximum rated (DC) voltage.

These IEC standards have been adopted by CENELEC (The European Committee for Electrotechnical Standardization) and have been identified by replacing IEC with EN 60 e.g.

IEC 947-5-1 then becomes **EN 60947-5-1**.

CENELEC has defined the dimensions and characteristics of two types of limit switch in the standards **EN 50041** and **EN 50047**.

These standards relate to **Low voltage switchgear and controlgear for industrial use** and define the enclosure dimensions, the operating point for various head actuators, the earth terminal requirement, the terminal marking and the minimum degree of IP protection.

ELECTRICAL RATINGS

| | | IEC947-5-1 / EN60947-5-1 | | | | | | | |
|------------------------------------|--|------------------------------|------|------|------|------|------|-----------|-------|
| Designation & Utilization Category | Rated operational current Ie (A) at rated operational voltage Ue | Rated operational voltage Ue | | | | | | VA rating | |
| | | 120V | 240V | 380V | 480V | 500V | 600V | Make | Break |
| AC15 | A600 | 6 | 3 | 1.9 | 1.5 | 1.4 | 1.2 | 7200 | 720 |
| AC15 | A300 | 6 | 3 | — | — | — | — | 7200 | 720 |
| AC15 | B300 | 3 | 1.5 | — | — | — | — | 3600 | 360 |
| AC14 | D300 | 0.6 | 0.3 | — | — | — | — | 432 | 72 |
| | | 125V 250V | | | | | | | |
| DC13 | Q300 | 0.55 | 0.27 | | | | | 69 | 69 |
| DC13 | R300 | 0.22 | 0.1 | | | | | 28 | 28 |

How to read and understand the bar chart information

The following example relates to a unit which has a snap action basic and which has a roller pin plunger actuator i.e. GLCB01C.

When reading these bar charts follow these rules:

1. Check what type of actuator was used to test the product, this is on the drawings which show the head style available. It will be one of two types:
 - a) Vertical travel plunger
 - b) Linear cam travel
2. Start reading from top left of figure B, at the arrow labeled “A”.
3. Follow the black arrows and the black strip on the chart. The black strip indicates that there is a circuit between the terminals whose numbers are shown on the left and when white there is no circuit.

All dimensions are in mm/(inches).

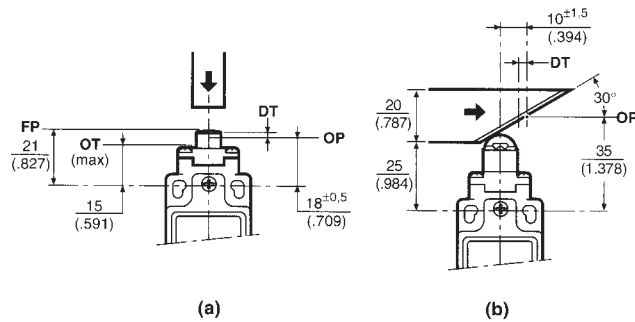

Figure A

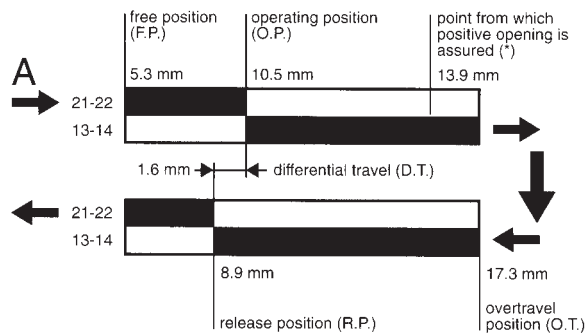

Figure B

Look at Figures A and B as examples. Actuator type used for test is the linear Cam travel type (b) shown left. The start point is at the arrow marked “A” (See fig. B). This shows the free position to be 5.3 mm from the vertical center line of the unit. At this stage there is a circuit between the terminals 21-22 but no circuit between terminals 13-14. The unit can be actuated until it reaches the operating position which is 10.5 mm from the center line – a travel distance of 10.5 – 5.3 = 5.2 mm from the free position. At this point the circuit arrangement changes – no circuit between 21-22 but making a circuit between 13-14. If, however, the contacts of terminals 21-22 weld together and will not separate, a mechanical safety feature will take effect if the switch is travelled past the point from which positive opening is assured, 13.9 mm. As the switch returns it reaches the release position at 8.9 mm from the center line. The circuit will change back to the original state and the difference between the operating position and the release position gives what is known as the differential travel i.e. 10.5 – 8.9 = 1.6 mm. The asterisk (*) indicates the point from which the positive opening is assured.

Limit and Enclosed Switches

Degree of Protection

IP Classification

The IEC 529 standard describes a system for classifying the degree of protection provided by the enclosures of electrical equipment.

The level of protection given by the enclosure is indicated by the IP code.

This code system uses the letters "IP" (International Protection) followed by up to four digits. Normally only the first two digits are used.



The first digit is numerical and indicates the level of protection within the enclosure against the ingress of solid foreign objects and access to hazardous parts by persons.

The second digit is also numerical and indicates the level of protection against the ingress of **WATER** into the enclosure.

The third digit is a letter and indicates a higher level of protection for persons against access to hazardous parts.

The fourth digit is also a letter and is used in exceptional cases for supplementary information.

If the first or second digit is not required to be specified, then it is replaced by the letter "X" ("XX" if both digits are not required).

While the tables below serve as a guide to the level of protection, Honeywell recommends that customers refer to the full official IEC specification for the exact definitions. If in doubt about the degree of protection required for a particular application, please consult your local Honeywell office.

Note:

The IEC 529 standard does not relate to protection against rust, corrosion, icing or corrosive solvents (e.g. cutting fluids) and that product coded IP 67 may not necessarily meet IP 66 requirements.

| First Digit | Protection against ingress of solid objects |
|-------------|--|
| IP | TEST |
| 0 | no protection |
| 1 | protected against solid objects with a diameter greater than 50 mm. |
| 2 | protected against solid objects with a diameter greater than 12 mm. |
| 3 | protected against solid objects with a diameter greater than 2.5 mm. |
| 4 | protected against solid objects with a diameter greater than 1 mm. |
| 5 | protected against dust-limited ingress (no harmful deposit) |
| 6 | totally protected against dust |

| Second Digit | Protection against ingress of water |
|--------------|--|
| IP | TEST |
| 0 | no protection |
| 1 | protected against vertically falling drops of water. |
| 2 | protected against vertically falling drops of water when the enclosure is tilted at an angle up to 15 degrees. |
| 3 | protected against water sprayed at an angle of 60 degrees from the vertical |
| 4 | protected against splashing water from all directions – limited ingress (no harmful effects) |
| 5 | protected against low pressure jets of water from all directions – limited ingress permitted |
| 6 | protected against powerful jets of water from all directions – limited ingress permitted |
| 7 | protected against the effects of temporary immersion in water |
| 8 | protected against the effects of continuous immersion in water |

NEMA Classification (USA)

NEMA (National Electrical Manufacturer's Association) prepares standards which define a product, process or procedure with reference to one or more of the following: nomenclature, composition, construction, dimensions, tolerances, safety, operating characteristics, performance, quality, electrical rating, testing and the service for which designed.

This standard provides degrees of protection for Enclosures for Electrical Equipment (1000 Volts Maximum) similar to that of the IEC 529 standard. The reference standard herein reflects the latest data in the NEMA Standards Publication when this information went to print.

Non-hazardous locations

Type 1 enclosures are intended for indoor use primarily to provide a degree of protection against contact with the enclosed equipment.

Type 3 enclosures are intended for outdoor use primarily to provide a degree of protection against windblown dust, rain, sleet, and external ice formation.

Type 4 enclosures are intended for indoor or outdoor use primarily to provide a degree of protection against windblown dust and rain, splashing water, and hose-directed water.

Type 4X enclosures are intended for indoor or outdoor use primarily to provide a degree of protection against corrosion, windblown dust and rain, splashing water, and hose-directed water.

Type 6 enclosures are intended for indoor or outdoor use primarily to provide a degree of protection against the entry of water during occasional temporary submersion at a limited depth.

Type 6P enclosures are intended for indoor or outdoor use primarily to provide a degree of protection against the entry of water during prolonged submersion at a limited depth.

Type 12 enclosures are intended for indoor use primarily to provide a degree of protection against dust, falling dirt, and dripping non-corrosive liquids.

Type 13 enclosures are intended for indoor use primarily to provide a degree of protection against dust, spraying water, oil and non-corrosive coolant.

Note: Enclosures are based, in general, on the broad definitions outlined in NEMA Standards. Therefore, it will be necessary to ascertain that a particular enclosure will be adequate when exposed to the specific conditions that might exist in intended applications. Except as might otherwise be noted, all references to products relative to NEMA enclosure type are based on Honeywell evaluation and Underwriter's Laboratory (UL) tested.

This NEMA Standards Publication does test for environmental conditions such as corrosion, rust, icing, oil, and coolants. The IEC 529 does not, and does not specify degree of protection against mechanical damage of equipment. For this reason, and because the tests and evaluations for other characteristics are not identical, the IEC Enclosure Classification Designations cannot be exactly equated with NEMA Enclosure Type Numbers.

Limit/Enclosed

Limit and Enclosed Switches

GLA – Metal Standard

GLF – (w/1 LED)

12...250Vac/dc

GLH – (w/2 LED)

18...30Vdc

EN 50041

Technical Data

Mechanical life up to 15 million operations

Degree of protection IP 67
NEMA/UL type 1, 4, 12, 13

Temperature range Operating:
-25°C to +85°C
-13°F to +185°F
Storage:
-40°C to +85°C
-40°F to +185°F

Approvals IEC 947-5-1
EN60947-5-1
AC15 A300/A600
DC13 Q300
UL & CSA

Vibration (Actuator not fitted) 10 g conforming to IEC 68-2-6

Shock (Actuator not fitted) 50 g conforming to IEC 68-2-27
Terminal marking to EN 50013

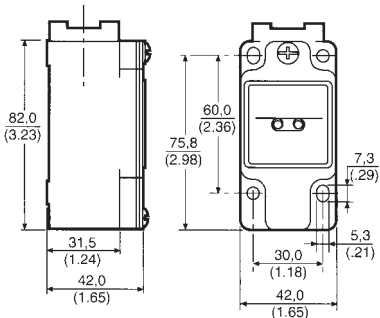

Conduit Thread

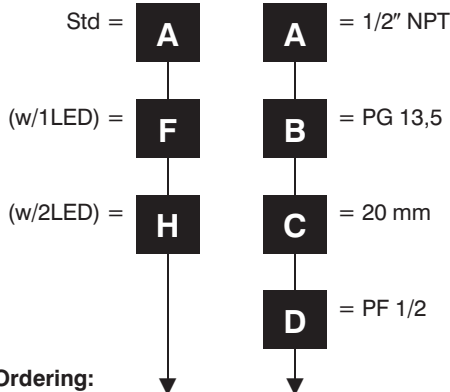

Ordering:



Example: GLA B 01 B — GLF B 01 B — GLH B 01 B

Snap-Action Contacts

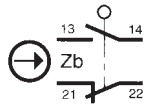

Circuit closed

* Positive opening to IEC 947-5-1-3

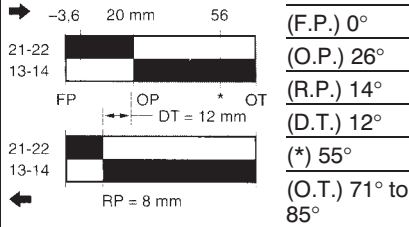

Slow-Action Contacts

BREAK BEFORE MAKE

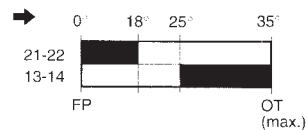
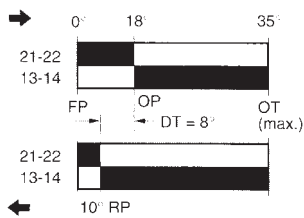
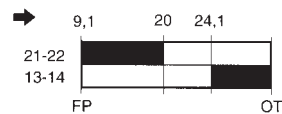
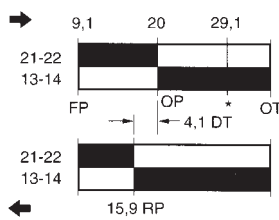
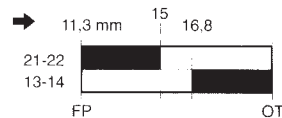
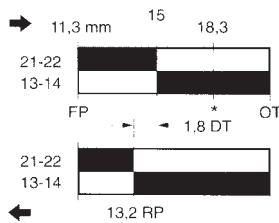
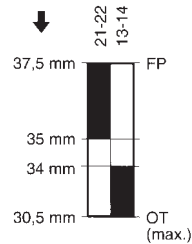
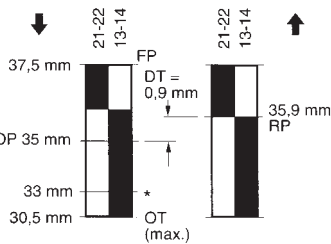
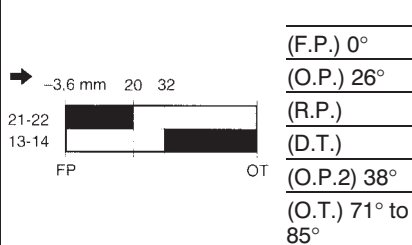
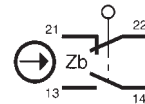

* Point from which the positive opening is assured.

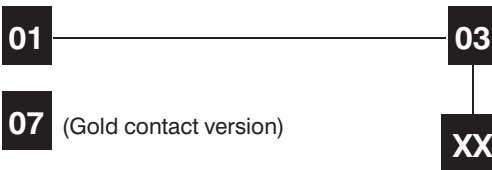

Limit and Enclosed Switches

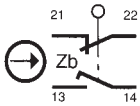
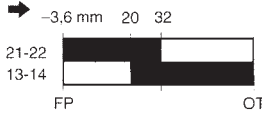
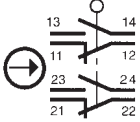
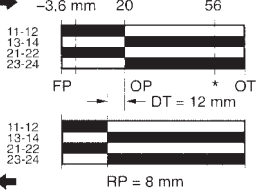
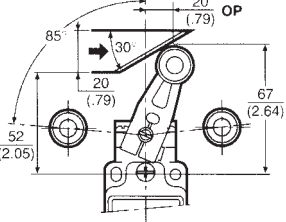
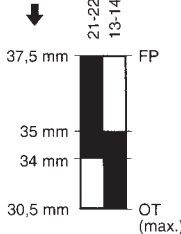
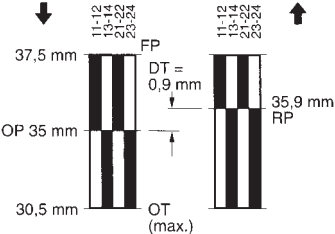
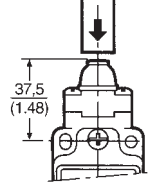
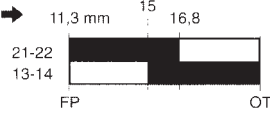
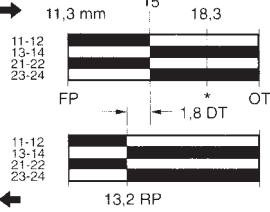
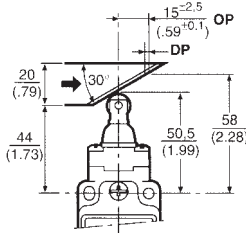
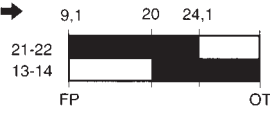
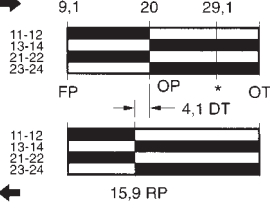
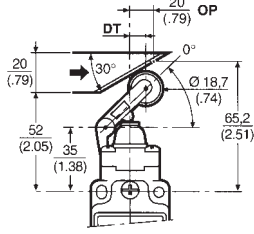
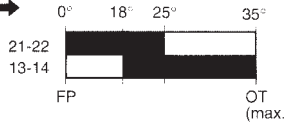
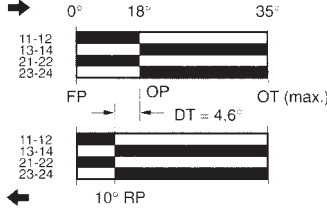
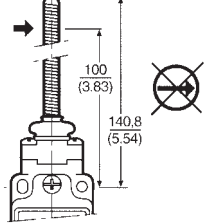
| Slow-Action Contacts MAKE BEFORE BREAK | Snap-Action Contacts DOUBLE POLE | Actuator Types |
|--|---|--|
|   (F.P.) 0° (O.P.) 26° (R.P.) (D.T.) (O.P.2) 38° (O.T.) 71° to 85° |   (F.P.) 0° (O.P.) 26° (R.P.) 14° (D.T.) 12° (*) 55° (O.T.) 71° to 85° |  A1B Additional levers available (see page A24) |
|  |  |  B |
|  |  |  C |
|  |  |  D |
|  |  |  E7B |

Limit/Enclosed

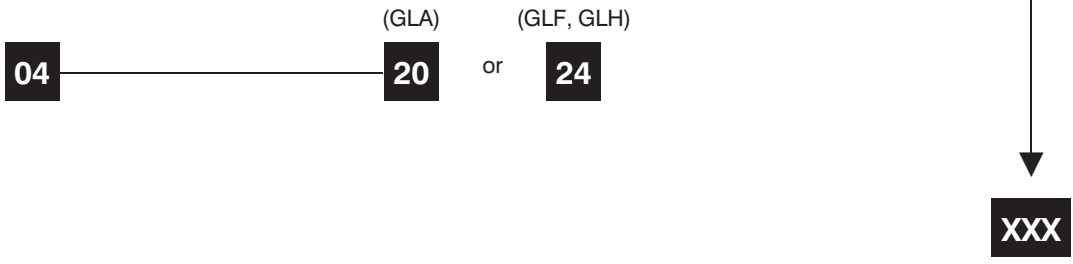

Limit and Enclosed Switches

Additional Lever Types

For use with all Side Rotary Head Style.

Figure 1 illustrates Miniature Din lever types conforming to EN 50047 while Figure 2 illustrates Standard Din lever types which conform to EN 50041.

All dimensions are in mm/(inches).

GLC, GLD, GLE (EN 50047)

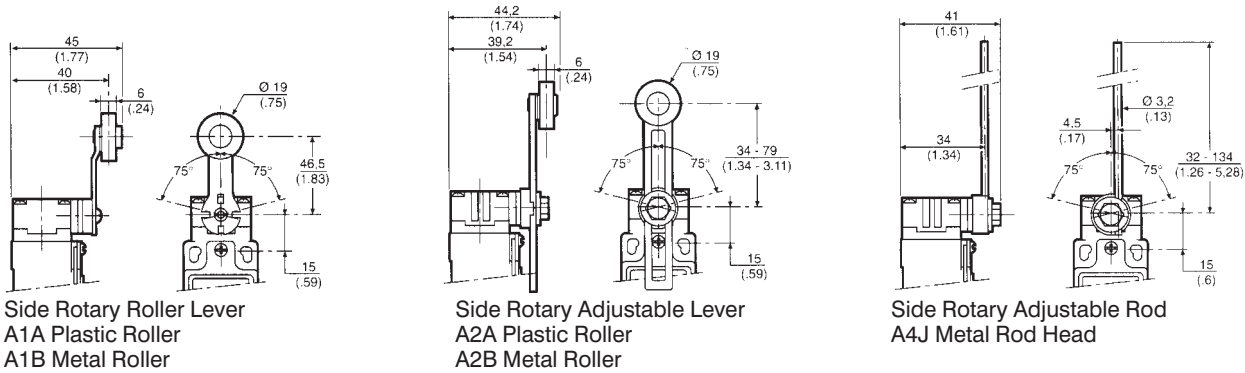

Side Rotary Roller Lever
A1A Plastic Roller
A1B Metal Roller

Side Rotary Adjustable Lever
A2A Plastic Roller
A2B Metal Roller

Side Rotary Adjustable Rod
A4J Metal Rod Head

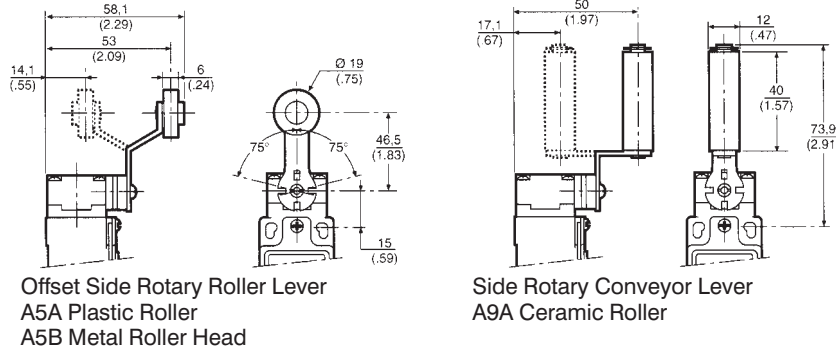

Offset Side Rotary Roller Lever
A5A Plastic Roller
A5B Metal Roller Head

Side Rotary Conveyor Lever
A9A Ceramic Roller

Figure 1

GLA, GLB, GLF, GLH, GLG, GLJ (EN 50041)

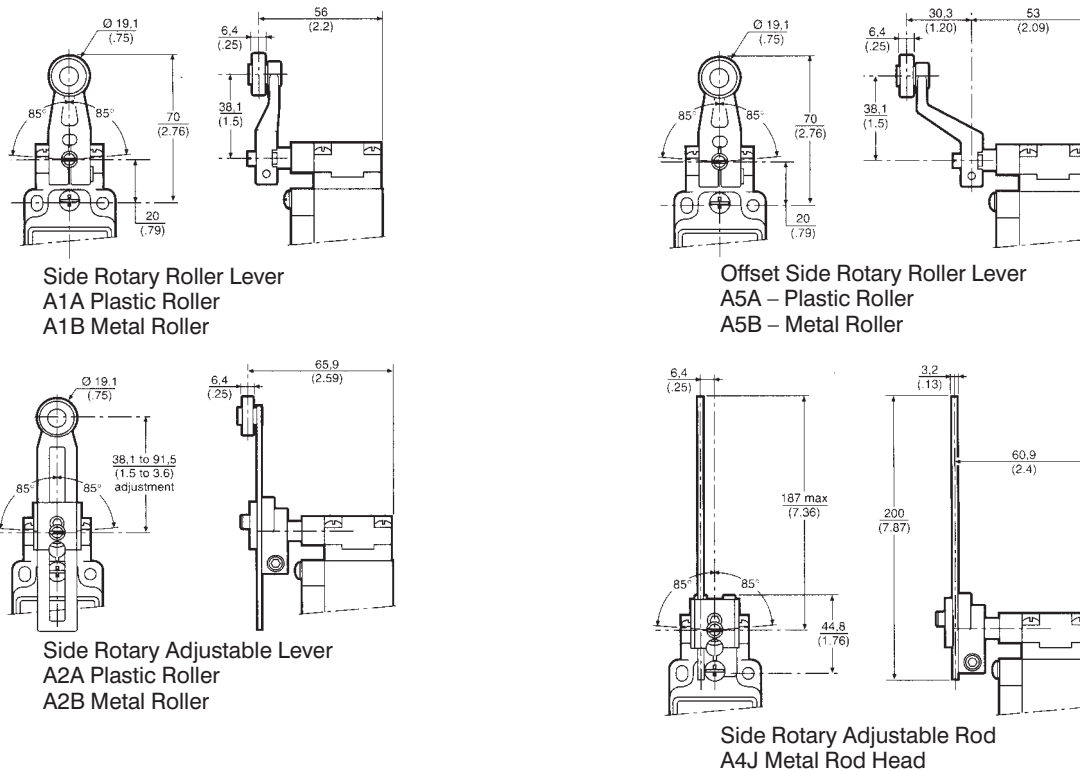

Side Rotary Roller Lever
A1A Plastic Roller
A1B Metal Roller

Offset Side Rotary Roller Lever
A5A - Plastic Roller
A5B - Metal Roller

Side Rotary Adjustable Lever
A2A Plastic Roller
A2B Metal Roller

Side Rotary Adjustable Rod
A4J Metal Rod Head

Figure 2

Limit and Enclosed Switches

Spare Parts for the GLS Series

To order spare parts for your particular GLS simply use the GLS number on the front of the switch to identify the construction used and therefore the spare part you need.

For Example: The part No: GLAB01E7B

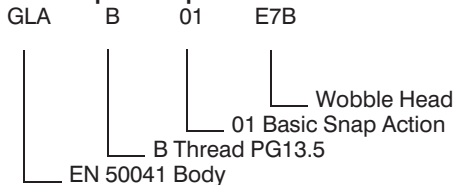

For Example: The part No: GLDC04A1B

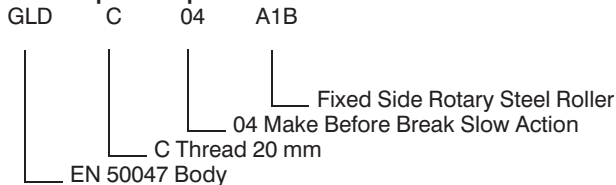

From the tables below it is possible to obtain replacement Basic Switches, Heads, Actuators, Levers and LED Assemblies.

Note: Spare parts should only be used to replace parts on existing listings. Honeywell accepts no liability for parts used in combinations not recognized by Honeywell as valid listings.

Basic Switches

| Body Type | 01 | Basic 02 | Switch 03 | 04 | 12 | 13 | 20 | 24 |
|-----------|--------|---------------------|-----------|--------|---------------------|---------------------|--------|--------|
| GLA | GLZ301 | | GLZ303 | GLZ304 | | | GLZ320 | |
| GLB | | GLZ302 ¹ | | | | | | |
| GLC | GLZ301 | | GLZ303 | GLZ304 | | | | |
| GLD | GLZ301 | | GLZ303 | GLZ304 | | | | |
| GLE | GLZ301 | | GLZ303 | GLZ304 | | | | GLZ324 |
| GLF | GLZ301 | | GLZ303 | GLZ304 | | | | |
| GLG | | | | | GLZ312 ¹ | | | |
| GLH | GLZ301 | | GLZ303 | GLZ304 | | | | |
| GLJ | | | | | | GLZ313 ¹ | | |

Note 1: For these spares you will receive the front of the body with no head. To replace the faulty switch/LED assembly remove the old body and old head. Retrofit the head onto the replacement and plug in the spare switch/LED assembly into the old base.

Heads

| Body Type | A | Head B | Types C | D | E7A | E7B | E7D | K8A | K8B | K8C |
|-----------|--------|--------|---------|--------|----------|----------|----------|----------|----------|----------|
| GLA | GLZ1AA | GLZ1AB | GLZ1AC | GLZ1AD | GLZ1AE7A | GLZ1AE7B | GLZ1AE7D | GLZ1AK8A | GLZ1AK8B | GLZ1AK8C |
| GLB | GLZ1AA | GLZ1AB | GLZ1AC | GLZ1AD | GLZ1AE7A | GLZ1AE7B | GLZ1AE7D | GLZ1AK8A | GLZ1AK8B | GLZ1AK8C |
| GLC | N/A | N/A | N/A | N/A | N/A | N/A | N/A | N/A | N/A | |
| GLD | N/A | N/A | N/A | N/A | N/A | N/A | N/A | N/A | N/A | |
| GLE | N/A | N/A | N/A | N/A | N/A | N/A | N/A | N/A | N/A | |
| GLF | GLZ1AA | GLZ1AB | GLZ1AC | GLZ1AD | GLZ1AE7A | GLZ1AE7B | GLZ1AE7D | GLZ1AK8A | GLZ1AK8B | GLZ1AK8C |
| GLG | GLZ1AA | GLZ1AB | GLZ1AC | GLZ1AD | GLZ1AE7A | GLZ1AE7B | GLZ1AE7D | GLZ1AK8A | GLZ1AK8B | GLZ1AK8C |
| GLH | GLZ1AA | GLZ1AB | GLZ1AC | GLZ1AD | GLZ1AE7A | GLZ1AE7B | GLZ1AE7D | GLZ1AK8A | GLZ1AK8B | GLZ1AK8C |
| GLJ | GLZ1AA | GLZ1AB | GLZ1AC | GLZ1AD | GLZ1AE7A | GLZ1AE7B | GLZ1AE7D | GLZ1AK8A | GLZ1AK8B | GLZ1AK8C |

Levers / Actuators (For GLZ1AA Head Type Only (side rotary))

| Body Type | 1A | Lever 1B | Actuator 2A | Type 2B | 4J | 5B |
|-----------|--------|----------|-------------|---------|--------|--------|
| GLA | GLZ51A | GLZ51B | GLZ52A | GLZ52B | GLZ54J | GLZ55B |
| GLB | GLZ51A | GLZ51B | GLZ52A | GLZ52B | GLZ54J | GLZ55B |
| GLC | N/A | N/A | N/A | N/A | N/A | N/A |
| GLD | N/A | N/A | N/A | N/A | N/A | N/A |
| GLE | N/A | N/A | N/A | N/A | N/A | N/A |
| GLF | GLZ51A | GLZ51B | GLZ52A | GLZ52B | GLZ54J | GLZ55B |
| GLG | GLZ51A | GLZ51B | GLZ52A | GLZ52B | GLZ54J | GLZ55B |
| GLH | GLZ51A | GLZ51B | GLZ52A | GLZ52B | GLZ54J | GLZ55B |
| GLJ | GLZ51A | GLZ51B | GLZ52A | GLZ52B | GLZ54J | GLZ55B |

Limit/Enclosed

Limit and Enclosed Switches

LED Assemblies

| Body Type | LED-Assembly 1-LED | TYPE 2-LED |
|-----------|-----------------------|---------------|
| GLA | | |
| GLB | | |
| GLC | | |
| GLD | | |
| GLE | | |
| GLF | GLZ6F | |
| GLG | | |
| GLH | | GLZ6H |
| GLJ | | |

Parts Description

| Heads | |
|----------------|--|
| GLZ1AA | Side Rotary Head |
| GLZ1AB | Top Pin Plunger Head |
| GLZ1AC | Top Roller Plunger Head |
| GLZ1AD | Roller Arm Head |
| GLZ1AE7A | Plastic Wobble Stick Head Assembly |
| GLZ1AE7B | Coil Wobble Stick Head Assembly |
| GLZ1AE7D | Coil Whisker Head Assembly |
| GLZ1AK8A | 140mm Cat's Whisker Head Assembly |
| GLZ1AK8B | 190mm Cat's Whisker Head Assembly |
| GLZ1AK8C | Cat's Whisker Head Assembly |
| Basics | |
| GLZ301 | Snap Action SPDT (01) |
| GLZ302 | Snap Action SPDT Plug-In (02) see Note 1 on page A25 |
| GLZ303 | SPDT Break Before Make (03) |
| GLZ304 | SPDT Make Before Break (04) |
| GLZ312 | Snap Action SPDT 1 LED Plug-In (12) see Note 1 on page A25 |
| GLZ313 | Snap Action SPDT 2 LED Plug-In (13) see Note 1 on page A25 |
| GLZ320 | Snap Action DPDT (20) |
| GLZ324 | Snap Action DPDT for 3 Conduit (24) |
| Actuators | |
| GLZ51A | Side Rotary Fixed Lever Nylon Roller Actuator |
| GLZ51B | Side Rotary Fixed Lever Steel Roller Actuator |
| GLZ52A | Side Rotary Adjustable Lever Nylon Roller Actuator |
| GLZ52B | Side Rotary Adjustable Lever Steel Roller Actuator |
| GLZ54J | Side Rotary Adjustable Rod Actuator |
| GLZ55B | Side Rotary Fixed Offset Lever Steel Roller |
| LED Assemblies | |
| GLZ6F | Spare 1 LED Assembly for GLF... |
| GLZ6H | Spare 2 LED Assembly for GLH... |

Limit and Enclosed Switches

Proper Application of Limit Switches

The following are guidelines for the correct application of Limit Switches.

Never use the Limit Switch as a physical end stop. Mechanical damage or incorrect operation may occur if this is done. Always ensure that the mechanical actuator is protected from excessive mechanical shock. Never release the actuator suddenly – gradual actuation and release will ensure that stress on the mechanics of the switch is kept to a minimum. This has the added benefit that the switch life will be improved.

The following diagrams illustrate how to actuate your limit switch for optimum performance.

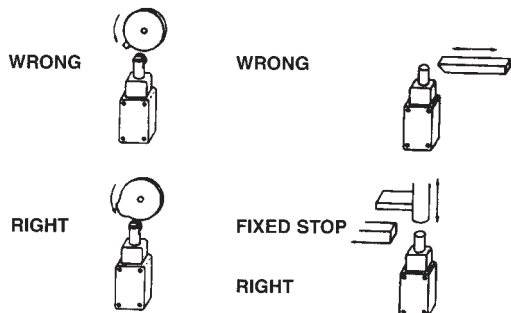

For limit switches with pushrod actuators, the actuating force should be applied as nearly as possible in line with the pushrod axis.

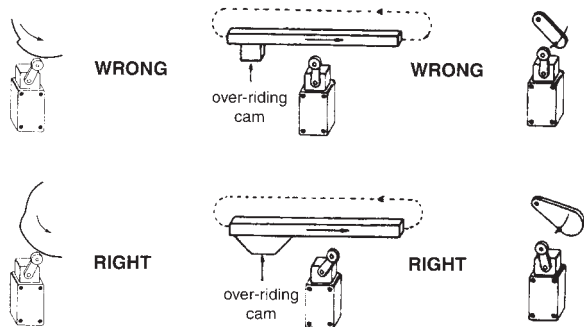

Cam or dog arrangements should be such that the actuator is **not** suddenly released to snap back freely.

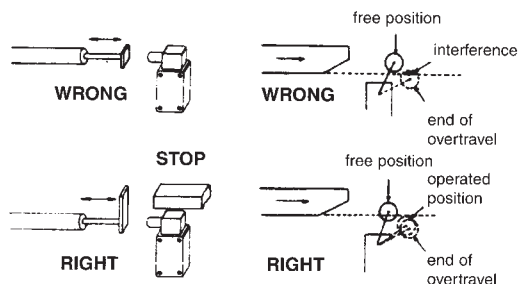

Operating mechanisms for limit switches should be so designed that, under any operating or emergency conditions, the limit switch is not operated beyond its overtravel limit position. A limit switch should not be used as a mechanical stop.

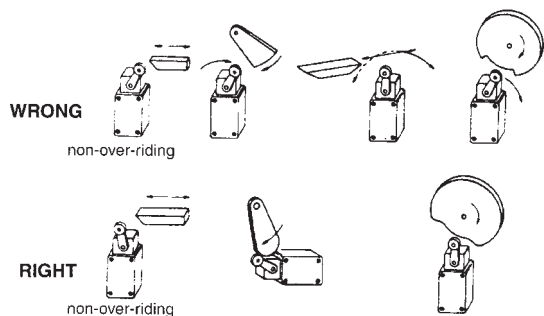

For limit switches with lever actuators, the actuating force should be applied as nearly perpendicular to the lever as practical and perpendicular to the shaft axis about which the lever rotates.

Tools

The following tools will be needed – depending on the task.

- Posidrive screwdriver n° 1 & n° 2
- Allen key 3 mm

When tightening a screw down the maximum force which should be applied should not exceed 80N.cm (7in.LB) on any screw on the complete assembly or basic switch terminal.

Mounting Instructions

Mounting, Installation and Wiring of the Limit Switch plays a critical role in the performance of the switch in service. Care should be taken in the position and orientation of the switch for optimum performance. All of the guidelines given below apply equally when replacing parts on the switch.

Wiring

The GLS series has been designed to accept 14AWG wire maximum. Care should be taken to ensure that the wires are carefully arranged in the switch so that they do not overlap or otherwise interfere with the operation of the switch when the switch cover is replaced. If the wires are trapped between the basic and the cover then the switch may fail to operate correctly – ensure that an adequate gap exists between the fitted wires and the cover when fitted. It is not good practice to have very different diameter wires share the same terminal in the switch – uneven pressure on the wires will result.

Mounting

The GLS series has been designed to be extremely flexible in mounting. Elongated mounting holes mean that the switch can be adjusted substantially prior to fixing in position. We recommend M4 maximum screws be used for mounting the switch in its application. Fix and test the switch for intended switch point in the application. When mounting the switch ensure that it is positioned to allow natural drainage of any moisture which may enter the enclosure during service. Natural drainage can be achieved by mounting the switch upright with the conduit entry at the bottom of the switch. Mounting the switch in the upright position will enable maintenance and replacement procedures to be carried out easily.

Adjustment and Set-up

In general no adjustment of the GLS should be necessary beyond correct mounting of the switch body as required. It is possible to change the switch actuator orientation. The example below shows a top roller plunger head rotated through 90°. The other head styles can also be rotated.

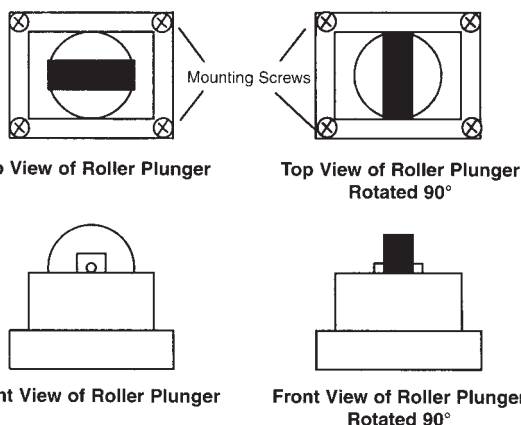

The head can be rotated by carefully removing the four combination head screws holding the head in position. Carefully remove the head assembly and rotate to the desired position. Replace the head assembly and tighten the mounting screws. Ensure that the head is properly located. Hand test the actuator to ensure that the switch functions and the actuator moves freely (sticking can occur if material has been deposited inside the drive train whilst the head assembly was removed).

Limit/Enclosed

Limit and Enclosed Switches

Side Rotaries

The side rotary assemblies incorporate a feature for adjusting the free position of the side rotary lever. The EN 50041 body style allows infinite adjustment and reclamp. The EN 50047 style allows clamping in 10° increments. See the following diagrams for details of the mechanism in each case.

Standard EN 50041 body style

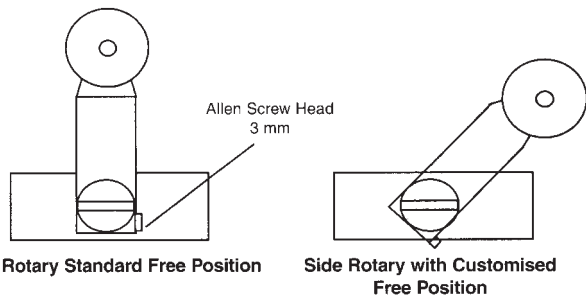

There are two lever mounting options: (1) By fully seating the lever in one of the four 90° detent positions on the shaft hub which provides positive lever retention; (2) By mounting the lever on the serrated portion of the shaft (which enables the lever to be mounted in any position).

To change the rotary lever's free position: (1) Use a 3 mm hex Allen wrench to loosen the Allen screw, as shown in the drawing above; (2) Back off the lever 2 mm and move it to the desired free position; (3) retighten the Allen screw; (4) Check to see if the free position is satisfactory for the application; (5) Repeat the adjustment procedure if necessary.

A teller tab located at the bottom of the lever (see diagram below) helps prevent lever slippage. It enables the installer to detect the correct tightening torque. When this tab cannot be moved, the Allen screw has been tightened properly.

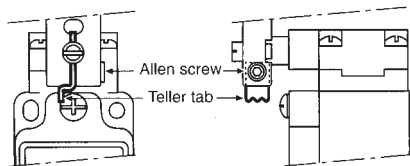

Miniature EN 50047 body style

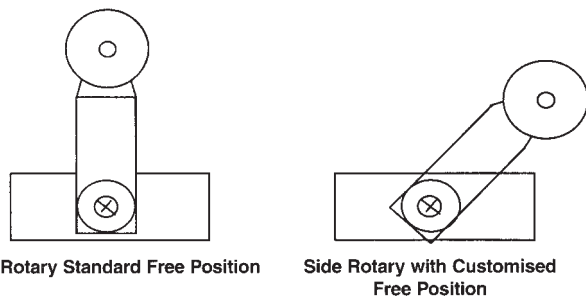

A serrated coupling is used to set the lever free position in 10° increments. This adjustment is achieved by: (1) Unscrewing the combination head screw which holds the lever in place, taking care not to lose any parts; (2) Readjust the assembly and rotate to the desired free position; (3) Re-assemble and tighten the combination screw. (4) Check that the free position is correct for the application and repeat the adjustment procedure if necessary.

NOTE: The lever can be set in 90° increments by removing the lever and rotating it to the desired 90° position.

EN 50041 Side Rotary Actuator Direction Adjustment

As furnished, GLS rotary switches will operate when the lever is rotated from either the left or right. They can be field modified to operate in one direction only (Clockwise CW; Counter clockwise CCW) by following these steps: (1) Carefully remove the complete head assembly; (2) Turn the head assembly upside down as shown in the drawing below.

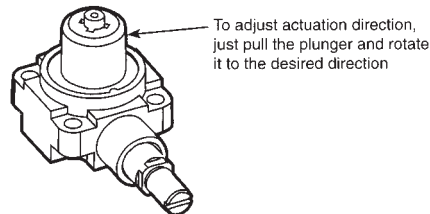

(3) Pull the plunger mechanism out and rotate it through 90° degree increments until the alignment tab points to the desired function (CW, CCW, or CW and CCW). (4) Push plunger mechanism in. (5) Reassemble the head assembly and re-test the switch in your application.

Replacement Instructions

All levers for side rotaries are available as replacement parts. All basics, except the plug-in, can be replaced. All EN 50041 heads can be replaced. The replacement procedures for these components are straightforward in nature.

Side Rotary Levers

Remove the old lever from the product being replaced. On EN 50041 product this is achieved by loosening the Allen screw holding the lever on the shaft. On EN 50047 product this is achieved by unscrewing the combination screw holding the lever on the shaft.

Replace the lever and tighten the Allen screw or combination screw. Retest the switch in its application.

Heads

All EN 50041 style switch heads can be removed and replaced.

Remove the old head by unscrewing the four retaining screws on the head assembly.

Ensure replacement part is identical to one being removed.

Re-test the assembly and ensure correct operation.

Basics

Non plug-in EN 50041 and three conduit EN 50047 body styles.

Basic switches can be removed and replaced by following this procedure: (1) Remove the cover from the body; (2) Before disconnecting the switch wiring, carefully note the wiring arrangement for your application, particularly the safety ground connection; (3) Remove the basic switch retaining screw; (4) Remove the old basic and replace it with the same thing; (5) Use the retaining screw to install the new basic – ensure that it is correctly seated in the switch body; (6) Wire the switch terminals as before; (7) Before replacing the cover – ensure that the switch wires are not twisted or otherwise lifted from the basic (to prevent them from becoming trapped when the cover is replaced); then (8) Test the switch in the application.

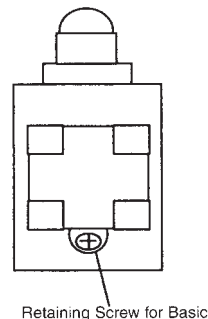

Limit and Enclosed Switches

Miniature EN 50047 body style

Use same replacement procedure as above except that no retaining screw is involved. The basic switch is secured in the miniature housings by a press fit. To remove an inoperative switch, merely grasp the basic firmly and pull it out of the housing. Insert the new switch in its place. Then wire the new basic as before and test it in the application.

Plug-in EN 50041 body style

The switch enclosure portion of this two-piece body style plugs into a pre-wired terminal block mounted in the application. Replacement is accomplished by unplugging the old switch enclosure and plugging-in a new switch enclosure (basics are permanently staked in the switch enclosure).

LED Wiring

The GLF, GLG, GLH and GLJ versions of GLS (EN 50041) come complete with LED indicators. These indicators can be wired in a variety of ways. The standard adopted in the GLG (1 LED Plug-in body) and in the GLJ (2 LED Plug-in body) versions is to use green to indicate power available and yellow to indicate operation. Operation can indicate actuator free or actuator operated depending on the wiring arrangement employed.

The table below indicates the body styles and indicators offered.

| Body | Function | Spec. |
|--------|---------------|--|
| GLF... | 1 LED | 12 → 250V AC and DC Less than 1,5mA draw |
| GLG... | 1 LED plug-in | 12 → 250V AC and DC Less than 1,5mA draw |
| GLH... | 2 LED | 18 → 30V DC 7mA typ. current draw |
| GLJ... | 2 LED plug-in | 18 → 30V DC 7mA typ. current draw |

The following wiring arrangements show possible configurations that can be used for the LED's. Combinations of these arrangements can be used where the dual LED versions of GLS are employed.

Typical Wiring Arrangement 1

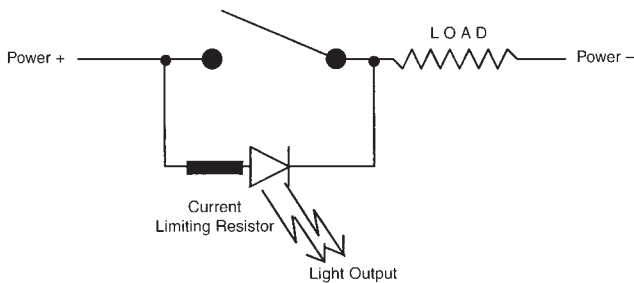

In "Wiring Arrangement 1" you can see that while the main basic is open the current for the LED can flow through the LED (via the load) and the LED illuminates.

Typical Wiring Arrangement 2

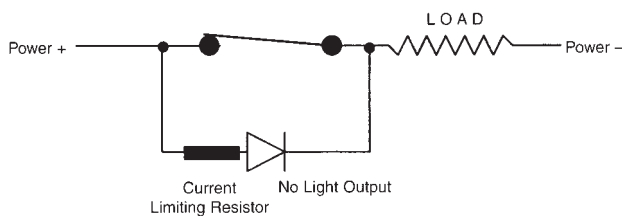

In "Wiring Arrangement 2" you can see that while the main switch is closed the current for the LED cannot flow through the LED and the LED will not illuminate.

Typical Wiring Arrangement 3

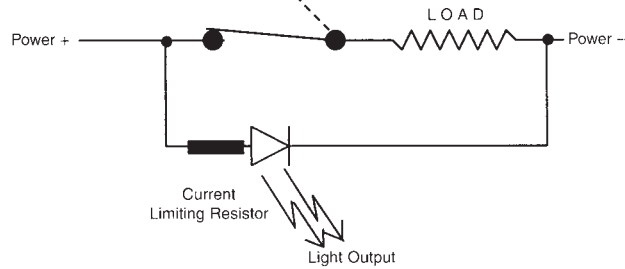

In "Wiring Arrangement 3" you can see that regardless of the position of the main switch the current for the LED can flow through the LED and the LED will illuminate indicating power available.

Typical Wiring Arrangement 4

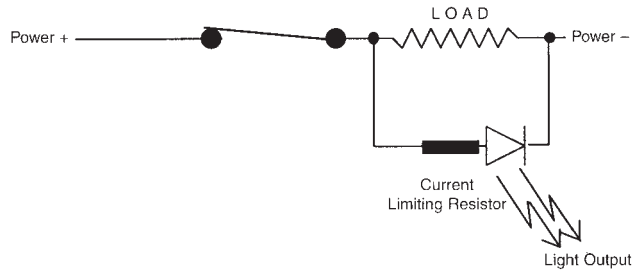

In "Wiring Arrangement 4" you can see that when the load is energised the LED will illuminate.

The above circuit ideas give a flavour for what is possible with these versions of GLS. The LED's should be treated as "for indication only" devices.

Note:

While every effort is made to ensure that the above guidelines are accurate, no responsibility can be accepted for failure to apply good engineering practice to machinery design and use of Honeywell products. Never apply any of the procedures outlined above on live circuits. Ensure that testing of changes is carried out with no risk of injury during tests. These guidelines are produced to help our customers make the right choices in applying our Limit Switches to general applications. Contact your local Honeywell representative if you have any difficulties.

Limit/Enclosed