

Rating	20A 12VDC	Mounting Hole	
Contact R	50m ohm Max.		
Insulation R	DC 500V 100M ohm Min.		
Dielectric Strength	AC 1500V 1 minute		
Operation Temperature	-20°~85°		
Circuit	3P SPST ON-OFF (LED)		

\*MATERIAL:  
 Frame: PA#66, Black  
 Actuator: PC  
 Waterproof: IP65

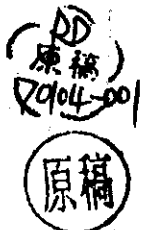
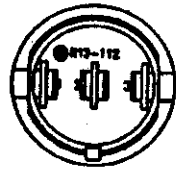
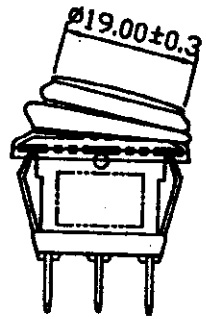
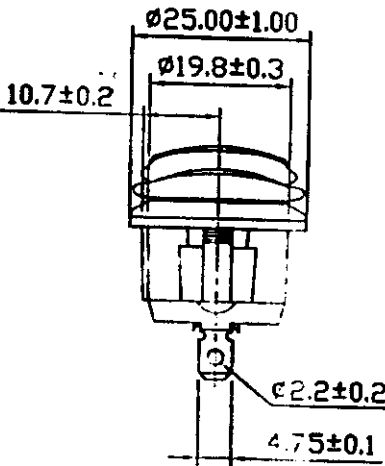
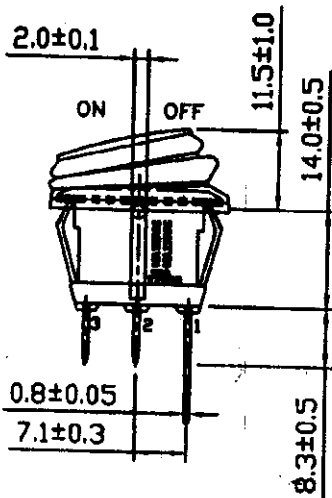
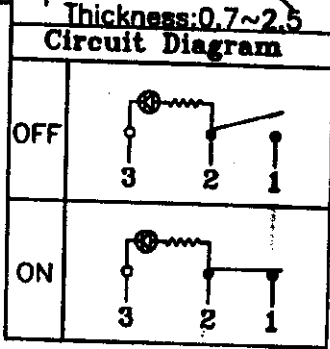
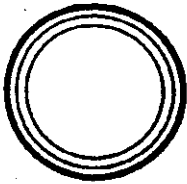

CB\R13\R13-112B8W-02(1823772~774)

1823774	Yellow
1823773	Green
1823772	Red
SCI NO.	Color

Date	Name	Description				NO
Drawing	Check	Approval	SCI No.	SEE TABLE	Model Name	ROCKER SWITCH
01/02/07	1/4/06	YB	Customer No.	mm	Model No.	R13-112B8W-02
SHIN CHIN INDUSTRIAL CO., LTD.						