

PAGE	
REV. NO	

# 部 品 承 認 願

CUSTOMER : \_\_\_\_\_

ITEM : SMD POWER INDUCTOR

PART NAME : HTOP4532 SERIES

MAKER : HANTER ELECTRONICS IND CO.,LTD.

APPROVED	REFEERENCE

( Date : 2013년 2월 25일 )

TESTED	CHECKED BY	APPROVED BY

## 남 선 전 자 주 식 회 사

서울시 구로구 구로동 1258번지 중앙유통단지 나동 3506-7호

TEL: 02-2689-9418/02-6679-9418 , FAX: 02-2689-8628

Homepage : [www.nsn.co.kr](http://www.nsn.co.kr) / E-mail : [sun@nsn.co.kr](mailto:sun@nsn.co.kr)



# APPROVAL SHEET



ITEM	:	SMD POWER INDUCTOR
P/NO	:	HTOP4532 SERIES
DATE	:	2013.02.25.

APPROVED	REFEERENCE

HANTER ELECTRONICS IND CO.,LTD  
JIANGNAN ZHUANG, WEISHAN TOWN WENDENG CITY  
SHANDONG, CHINA

改訂 REV.	設計變更 ENG.CHANGE	日付 DATE	作成 DRAWN	檢認 APPD.
------------	--------------------	------------	-------------	-------------

Record of Revisions				
Rev No.	Rev Date	Revision Contents	Reason of Rev.	Marking Method
1	2013.02.25	NEW		

QUALITY & DEVELOPMENT TEAM				尺圖 SCALE	SMD INDUCTOR for POWER LINE
擔當 DRAWN	設計 DESIGNED	檢認 CHECKED	承認 APPROVED	/ NTS	
				DIM. mm	
				HTOP4532 SERIES	
				1 / 6	

改訂 REV.	設計變更 ENG.CHANGE	日付 DATE	作成 DRAWN	檢認 APPD.
------------	--------------------	------------	-------------	-------------

### 1. DIMENSION (UNIT : mm)

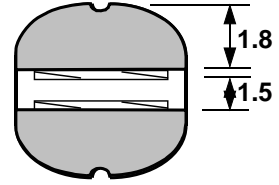
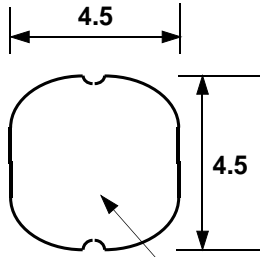

\* MARKING SPEC.  
ex)220uH--221

Tolerance  $\pm 0.2$

### 2. CONNECTION

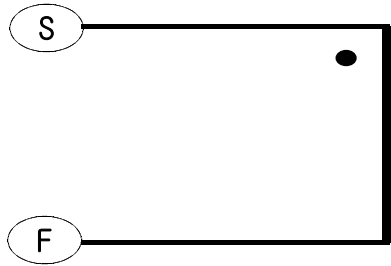

### 3. PCB-LAND PATTERN

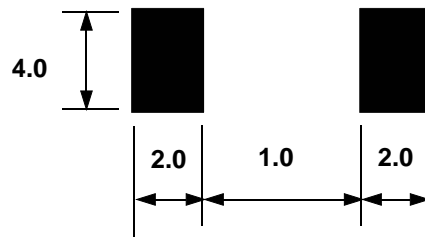



QUALITY & DEVELOPMENT TEAM				尺圖 SCALE	SMD INDUCTOR for POWER LINE
擔當 DRAWN	設計 DESIGNED	檢認 CHECKED	承認 APPROVED	/ NTS	
				DIM. mm	
				HTOP4532 SERIES	
				2 / 6	

改訂 REV.	設計變更 ENG.CHANGE	日付 DATE	作成 DRAWN	檢認 APPD.
------------	--------------------	------------	-------------	-------------

#### 4. ELECTRICAL PERFORMANCE

P/NO.	INDUCTANCE [uH±20% ]	DC RESISTANCE [ Ω MAX ]	RATED CURRENT [ A MAX ]	MARKING
HTOP-4532-1R0M	1.0	0.033	3.80	1R0
2R2M	2.2	0.047	2.60	2R2
3R3M	3.3	0.058	2.15	3R3
4R7M	4.7	0.094	1.70	4R7
5R6M	5.6	0.101	1.60	5R6
6R8M	6.8	0.117	1.40	6R8
8R2M	8.2	0.132	1.26	8R2
100M	10	0.182	1.10	100
150M	15	0.235	0.92	150
220M	22	0.378	0.76	220
330M	33	0.540	0.64	330
390M	39	0.587	0.59	390
470M	47	0.844	0.54	470
560M	56	0.937	0.50	560
680M	68	1.170	0.48	680
820M	82	1.200	0.46	820
101M	100	1.520	0.44	101
121M	120	1.800	0.43	121
151M	150	1.950	0.35	151
181M	180	2.230	0.33	181
221M	220	3.000	0.30	221
331M	330	4.250	0.26	331
391M	390	4.590	0.24	391
471M	470	6.690	0.22	471
561M	560	6.890	0.19	561
681M	680	7.010	0.17	681
821M	820	7.210	0.14	821
102M	1000	7.420	0.12	102

QUALITY & DEVELOPMENT TEAM				尺圖 SCALE	SMD INDUCTOR for POWER LINE
擔當 DRAWN	設計 DESIGNED	檢認 CHECKED	承認 APPROVED	/ NTS	
				DIM. mm	
				HTOP4532 SERIES	
				3 / 6	

改訂 REV.	設計變更 ENG.CHANGE	日付 DATE	作成 DRAWN	檢認 APPD.
------------	--------------------	------------	-------------	-------------

- \* INDUCTANCE : HP-4284A LCR METER at 100kHz, 0.25V.
- \* DC RESISTANCE : HIOKI 3220mΩHI TESTER.
- \* RATED CURRENT : The maximum DC value having inductance decrease within 10% and Temperature increase within 40°C by the application of DC bias.

### 5. INTERNAL CONSTRUCTION & MATERIAL LIST

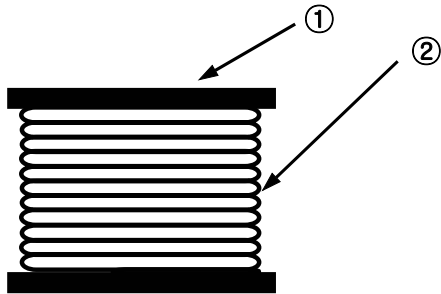

N O.	PART NAME	MATEARIAL
1	CORE	FERRITE
2	WIRE	UEW or eqv.



QUALITY & DEVELOPMENT TEAM				尺圖 SCALE	SMD INDUCTOR for POWER LINE
擔當 DRAWN	設計 DESIGNED	檢認 CHECKED	承認 APPROVED	/ NTS	
				DIM. mm	
				HTOP4532 SERIES	
				4 / 6	

改訂 REV.	設計變更 ENG.CHANGE	日付 DATE	作成 DRAWN	檢認 APPD.
------------	--------------------	------------	-------------	-------------

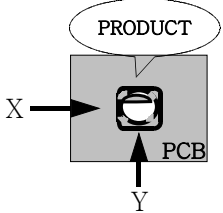
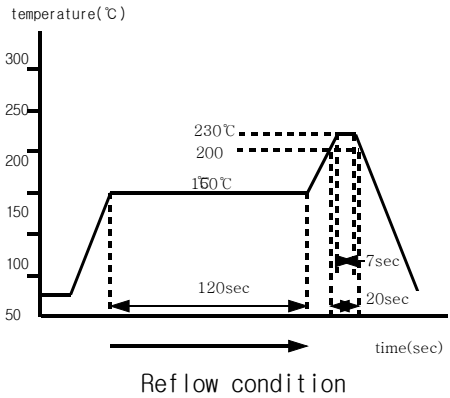
## 6. RELIABILITY DATA

NO	ITEM	SPECIFICATION	TEST METHOD & CONDITION
1	Operating temperature range	-25 to +85℃	Including temperature rise due to self-generated heat.
2	Storage temperature range	-40 to +85℃	
3	Insulation resistance	100MΩ min.	100VDC for 1min. between coil & core.
4	High Temperature	Inductance change : within ±10%	85℃ 96 Hours.
5	Low Temperature		-25℃ 96 Hours.
6	Humidity		40±2℃ 90~95% 500 Hours.
7	Thermal shock		-25±3℃ 30 Minutes Room Temp. Within 5 Minutes 85±2℃ 30 Minutes : 5 cycle
8	Vibration	Inductance change : within ±5%	vibration for 2hours in each of three orientations at sweep vibration 10 to 55 to 10Hz with 1.5mm P-P amplitude .
9	Solderability	Wetting shall cover less than 75% of each terminal	Solder temperature : 260 ±5℃ Duration : 3 ±2sec.
10	Resistance to soldering heat	No mechanical defect and Inductance change : within ±5%	Soler temperature : 260 ±5℃ Duration : 10 ±2sec.
11	Terminal strength	0.5kg for 10 ±1 seconds. Terminal should not peel off	 <p>After soldering between copper plate and terminals of x,y with standing at below conditions</p>
12	Reflow condition	No mechanical defect and No Inductance defect	 <p>Reflow condition</p>

※ Measure after leave 2hours in standard condition(No 4~8).

QUALITY & DEVELOPMENT TEAM				尺圖 SCALE		SMD INDUCTOR for POWER LINE
擔當 DRAWN	設計 DESIGNED	檢認 CHECKED	承認 APPROVED	/	NTS	
				DIM.	mm	
HTOP4532 SERIES						5 / 6

改訂 REV.	設計變更 ENG.CHANGE	日付 DATE	作成 DRAWN	檢認 APPD.
------------	--------------------	------------	-------------	-------------

### 7. PACKING SPEC.

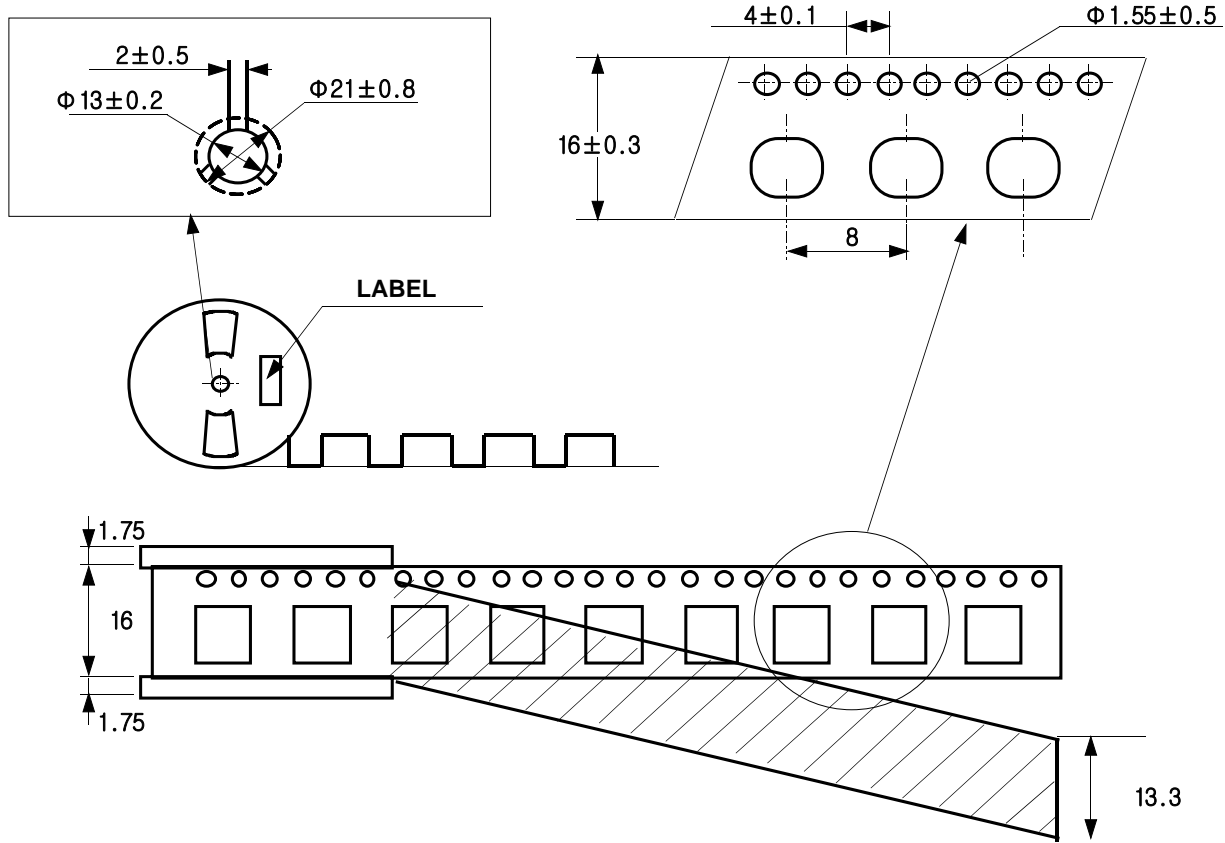

TAPE PITCH	8mm
EMBOSE TAPE	16mm
REEL	$\Phi 330 \pm 2$ mm
QUANTITY	2000 pcs
REEL TAPE MARGIN	START : 200mm MIN
	FINISH : 200mm MIN
COVER TAPE	13.3mm

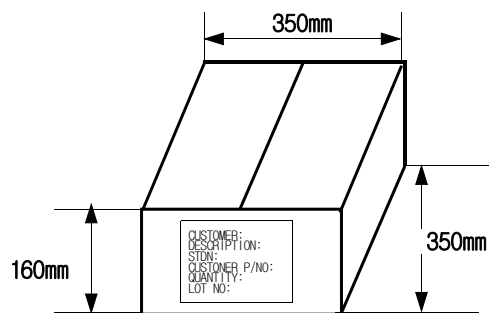

QUALITY & DEVELOPMENT TEAM				尺圖 SCALE	SMD INDUCTOR for POWER LINE	
擔當 DRAWN	設計 DESIGNED	檢認 CHECKED	承認 APPROVED	/ NTS		
				DIM. mm		
					HTOP4532 SERIES	6 / 6