



SPECIFICATIONS for Approval sheet

Item : Micro Speaker
Model : SG-208C38-01A

		Prepared	Checked	Approved
	Name			
	Sign.			
		Prepared	Checked	Approved
	Name	P.C.S		C.K.M
	Sign.			

SPECIFICATION

Product	Micro speaker	Issued date	04-Aug-14
Part No.	SG-208C38-01A	Page No.	2 of 4

1. Physical dimension.

Diameter	15 mm (Refer to drawing)
Thickness	5.5 mm (Refer to drawing)
Weight	3.6g ± 0.3g

2. Electric characteristics.

Impedance	8 Ω ± 15 % at 1.0V 1KHz.
S.P.L.	90 dB ± 3 dB at 0.8 , 1.0 , 1.2 , 1.5 KHz. Average figures / 4 Pts .
Power	Nor. : 1.0 W (2.83V)
	Max. : 1.5 W (3.46V)
Resonant Frequency (Fo)	670 Hz ± 20% at 1.0 V
Effective Frequency band	Fo ~ 20 KHz.
Distortion	Less than 5% at 1 KHz 0.1 W.
Buzz & rattle , etc.	Not be audible at 2.83 V sine wave, Fo ~ 20 KHz.
Load Test	Must be normal with program source 1.0 W. / (2.83V) White noise(EIA) / 96 Hrs.
Magnet	9.8 mm × 1.1 T (Rare Earth Permanent Magnet)
Leakage Flux	Front Cover Surface Center : MAX 1000 Gauss

3. Environment Test

High Temperature	+85 °C ± 3 °C 96 Hrs and keep 6 Hrs in a room.
Low Temperature	-40 °C ± 3 °C 96 Hrs and keep 6 Hrs in a room.
Humidity Resistance	+40 °C ± 3 °C 90 % ± 5% 96 Hrs.
Operation Temperature Range	-40 °C ± 3 °C ~ +60 °C ± 3 °C
Storage Temperature Range	-40 °C ± 3 °C ~ +70 °C ± 3 °C

SPECIFICATION

Product	Micro speaker	Issued date	04-Aug-14
Part No.	SG-208C38-01A	Page No.	3 of 4

4. Frequency curve.

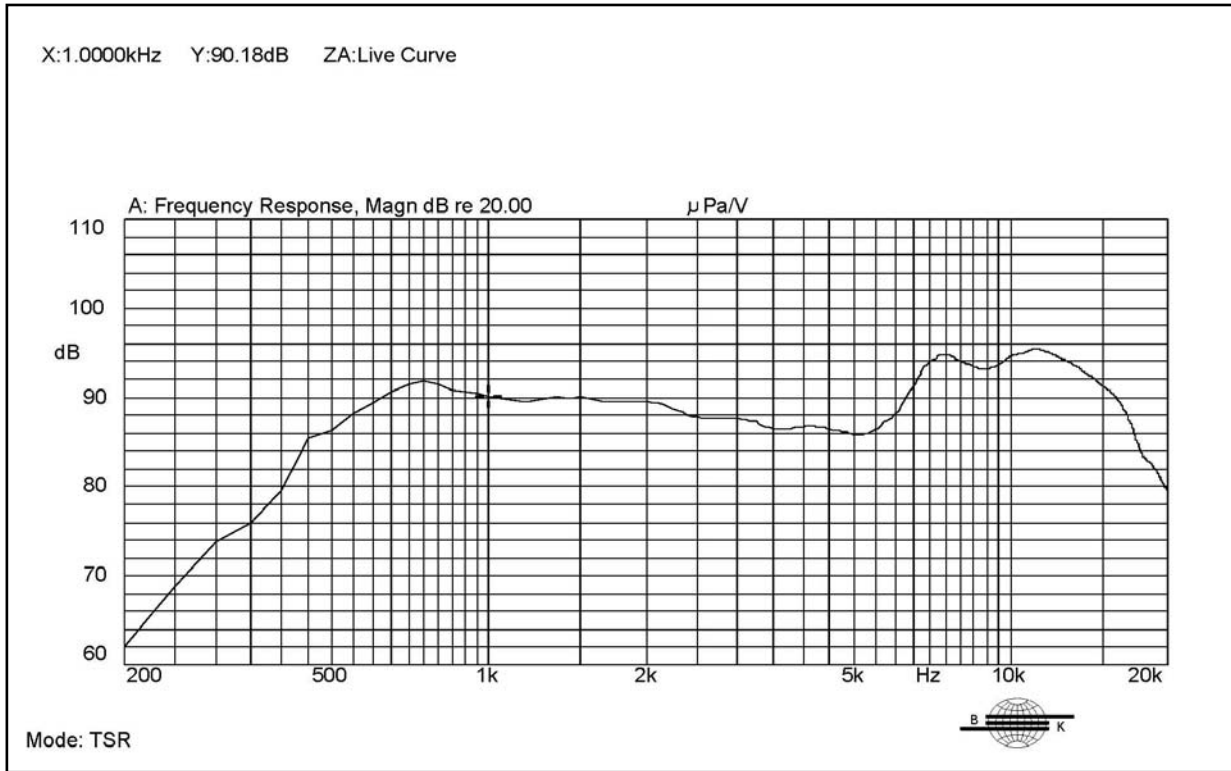

5. Test diagram.

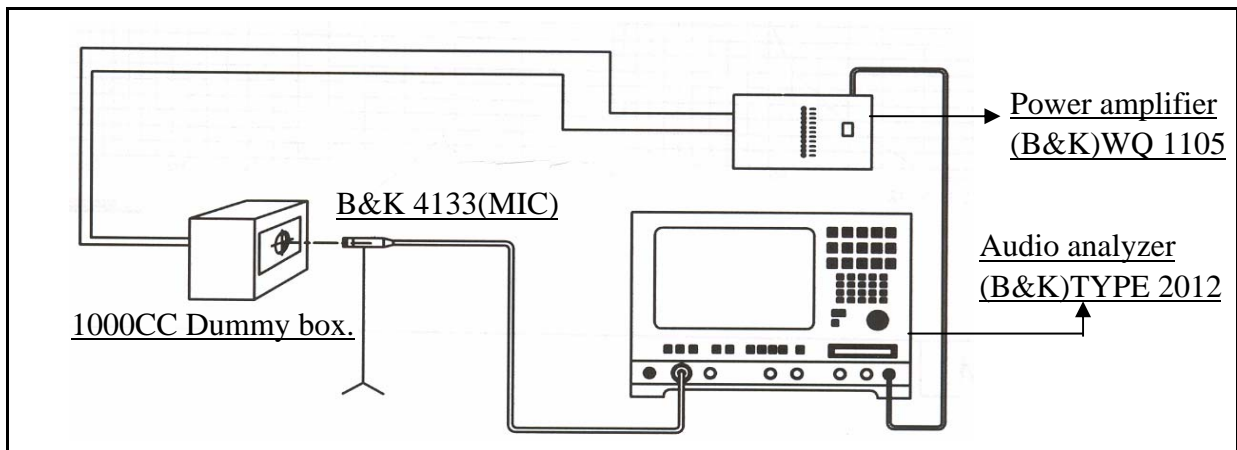

6. Measurement condition.

Microphone	B&K 4133	Zero level	60 dB
Mode	TSR	Input power	0.1 W
Mic distance	0.1m	Sweep time	0.5Sec

Model No.		SG-208C38-01A		Page No.		4 of 4	
REV.NO	DATE	DESCRIPTION		DRAW.BY	CHKD.BY	APP.BY	

MARKING

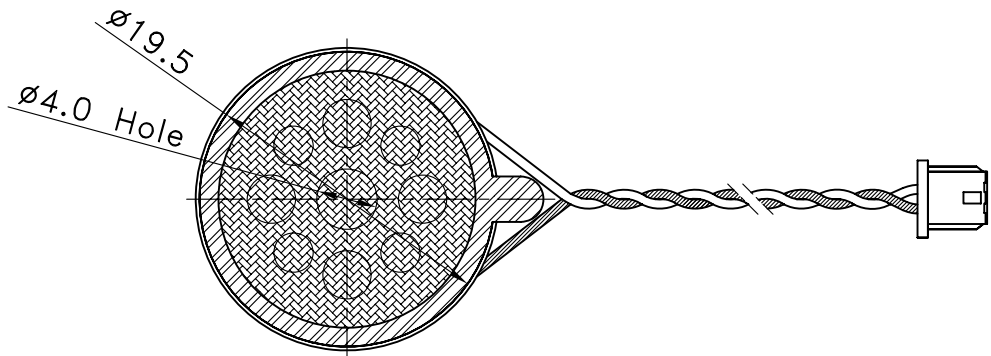
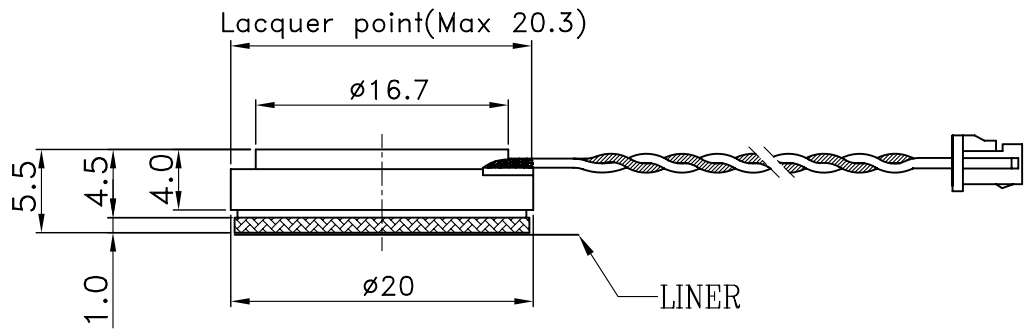
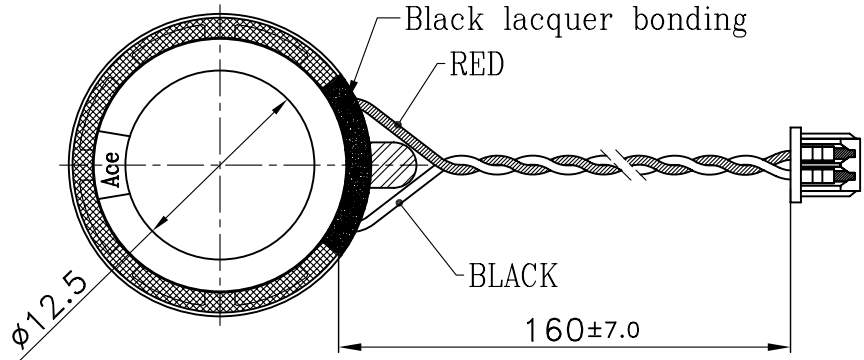
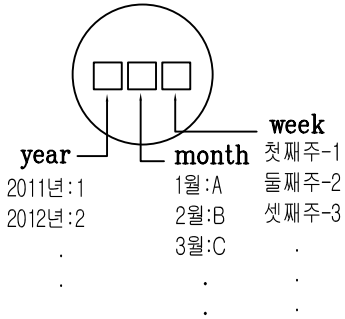

NOTE

1. WIRE: (UL1571/AWG28)
2. COLOR: (RED/BLACK)
3. CONNECTOR: (H: 20017HS-02)

PART NO.	PART NAME		MATERIAL			REMARK
UNIT	mm	DRAW.BY	CHKD.BY	APP.BY	DATE	04 - AUG - 2014
SCALE	2 : 1	D.W.P	J.H.MOON	I.G.SONG	MODEL NO.	SG-208C38-01A
TOL	± 0.2	2014.08.04	2014.08.04	2014.08.04	NOMENCLATURE	MODEL DIMENSION
FRM.UA-G-004-03 Rev.0 SG					.A4(297 X 210)mm	