



KERN & Sohn GmbH

Ziegelei 1
D-72336 Balingen
email: info@kern-sohn.com

Phone: +49-[0]7433- 9933-0
Fax: +49-[0]7433-9933-149
Internet: www.kern-sohn.com

Operating instructions Compact balance

KERN FFN-N

Version 2.2
11/2012
GB



FFN-N-BA-e-1222



KERN FFN-N

Version 2.2 11/2012

Operating instructions Compact balance

Table of Contents

1	Technical Data	4
1.1	Dimensions	6
2	Appliance Overview	7
2.1	Overview of displays	7
2.1.1	Not verifiable models	7
2.1.2	Verifiable models	7
2.2	Keyboard Overview	9
3	Basic Information	10
3.1	Proper use	10
3.2	Improper use	10
3.3	Warranty	10
3.4	Monitoring of Test Resources	10
4	Basic Safety Precautions	11
4.1	Pay attention to the instructions of the Operation Manual	11
4.2	Personnel training	11
5	Transportation & Storage	11
5.1	Testing upon acceptance	11
5.2	Packaging / return transport	11
6	Unpacking, Setup and Commissioning	12
6.1	Installation Site, Location of Use	12
6.2	Unpacking and implantation	13
6.2.1	Scope of supply	15
6.3	Battery power supply	15
6.3.1	Mains connection during rechargeable battery operation	17
6.4	Initial Commissioning	18
6.5	Protection type IP65	18
7	Adjustment	18
7.1	Adjustment	18
7.1.1	Adjusting non-verifiable models	19
7.1.2	Adjusting verifiable models	20
7.2	Verification	21
7.2.1	Adjustment switch and seals	22

8	Operation.....	23
8.1	Weighing.....	23
8.2	Taring.....	23
8.3	Weighing units switch-over.....	24
8.4	Background illumination	24
9	The menu.....	25
9.1	Navigation in the menu.....	25
9.2	Menu overview.....	26
9.3	Set auto-OFF function	27
9.4	Setting the Multi-Tare function.....	28
10	Error messages.....	29
11	Instant Help	30
12	Service, maintenance, disposal.....	31
12.1	Cleaning.....	31
12.2	Service, maintenance	31
12.3	Disposal.....	31

1 Technical Data

KERN	FFN 3K0.5IPN	FFN 6K1IPN	FFN 15K2IPN	FFN 25K5IPN
Weighing range (max)	3 kg	6 kg	15 kg	25 kg
Readability (d)	0,5 g	1 g	2 g	5 g
Reproducibility	0,5 g	1 g	2 g	5 g
Linearity	1 g	1 g	4 g	10 g
Recommended adjustment weight, not added (class)	3 kg (M3)	6 kg (M3)	15 kg (M3)	25 kg (M3)
Stabilization time (typical)	2 sec.			
Units	kg, lb			
Warm-up time	30 min.			
Electric Supply	Supply voltage: 110V-230V AC Mains adapter: 12 V, 0,8 A			
Battery power supply	Operating period: Background lighting on: 30 h Background lighting off: 50 h Loading time: 12 h			
Auto-off (Rechargeable battery)	15 min., 5 min., 3 min., off			
Display mode	LCD, digit size 25 mm			
Operating temperature	0° C + 40° C			
Humidity of air	25 % - 95 % (non-condensing)			
Weighing plate dimensions (stainless steel) (mm)	230 x 190			
Casing dimensions	230 x 300 x 130			
Total dimensions mounted (mm)	230 x 300 x 130			
Weight kg (net)	3,2			
IP protection	IP65			

KERN	FFN 3K1IPM	FFN 6K2IPM	FFN 15K5IPM	FFN 25K10IPM
Weighing range (max)	3 kg	6 kg	15 kg	25 kg
Readability (d)	1 g	2 g	5 g	10 g
Minimum weight	20 g	40 g	100 g	200 g
Verification values (e)	1 g	2 g	5 g	10 g
Accuracy class	III	III	III	III
Reproducibility	1 g	2 g	5 g	10 g
Linearity	1 g	2 g	5 g	10 g
Recommended adjustment weight, not added (class)	3 kg (M3)	6 kg (M3)	15 kg (M3)	25 kg (M3)
Stabilization time (typical)	2 sec.			
Units	kg, g			
Anwärmzeit	10 min.			
Electric Supply	Supply voltage: 110V-230V AC Mains adapter: 12 V, 0,8 A			
Battery power supply	Operating period: Background lighting on: 30 h Background lighting off: 50 h Loading time: 12 h			
Auto-off (Rechargeable battery)	15 min., 5 min., 3 min., off			
Display mode	LCD, digit size 25 mm			
Operating temperature	-10° C ... + 40° C			
Humidity of air	25 % - 95 % (non-condensing)			
Weighing plate dimensions (stainless steel) (mm)	230 x 190			
Casing dimensions	230 x 300 x 130			
Total dimensions mounted (mm)	230 x 300 x 130			
Weight kg (net)	3,2			
IP protection	IP65			

1.1 Dimensions

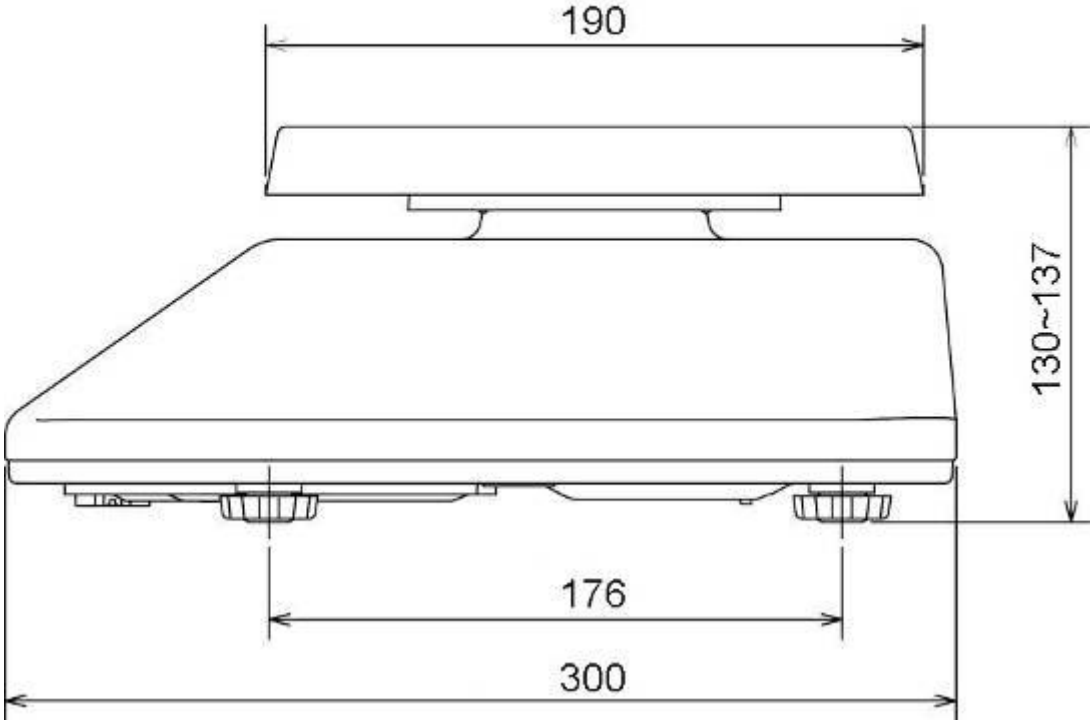
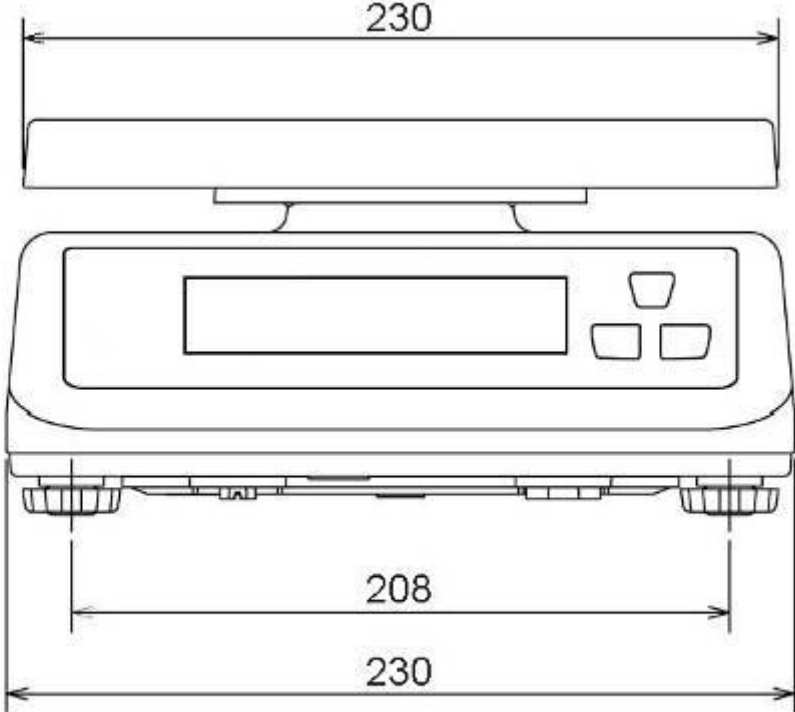

2 Appliance Overview



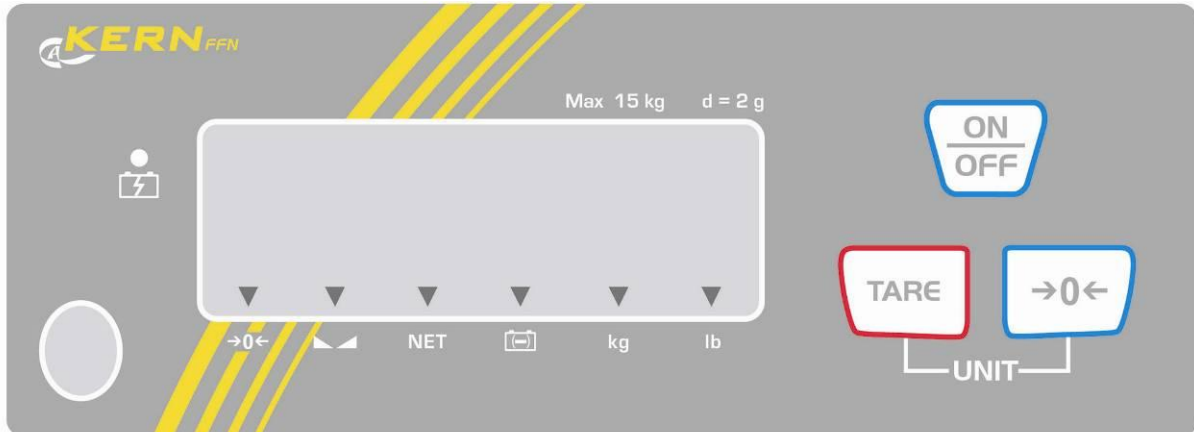

2.1 Overview of displays

2.1.1 Not verifiable models

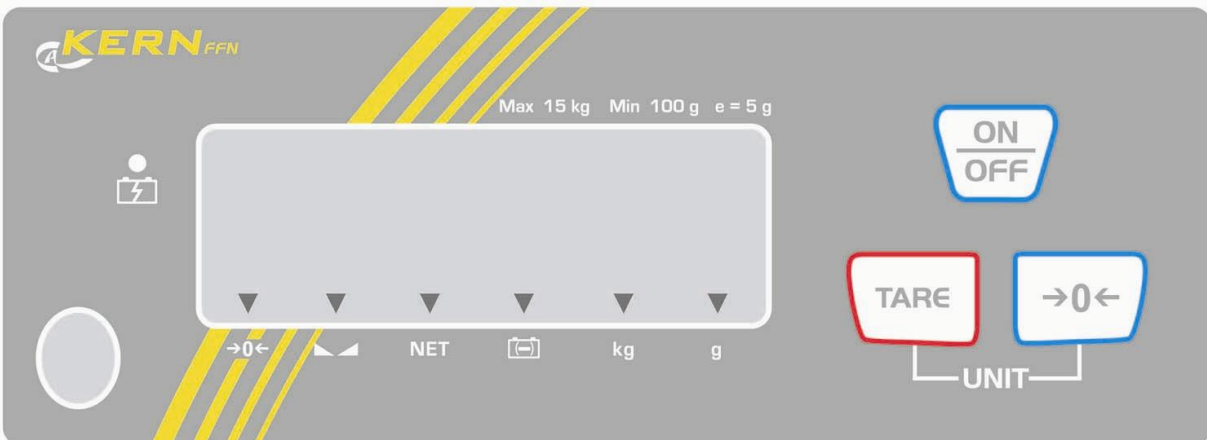





2.1.2 Verifiable models

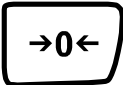

Display	Designation	Description
→0←	Zeroing display	Should the balance not display exactly zero despite empty scale pan, press the  button. Will be reset to zero after short waiting time.
	Stability display	Scales are in a steady state
NET	Net weight display	Net weight will be displayed
	Capacity display Rechargeable battery	Rechargeable battery almost empty, please connect power pack
	Power supply connected	Icon is glowing for power supply via power pack
kg	Display weighing unit kg	Displayed weight in kg
lb (only in not verifiable units)	Display weighing unit lb	Displayed weight in lb
g (only in verifiable units)	Display weighing unit g	Displayed weight in g

2.2 Keyboard Overview

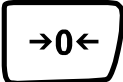
Button	Designation	Function	in the menu
	ON/OFF-switch	Turn on/off	
	TARE button	Tare balance	<ul style="list-style-type: none">▪ Call up menu▪ Change to the next menu item /parameter
	Zero setting key	Balance set at zero	<ul style="list-style-type: none">▪ Select menu item / parameter
	TARE + ZERO-key	Change units	
			
			

3 Basic Information

3.1 Proper use

The balance you purchased is intended to determine the weighing value of material to be weighed. It is intended to be used as a “non-automatic” balance, i.e. the material to be weighed is manually and carefully placed in the centre of the weighing plate. As soon as a stable weighing value is reached the weighing value can be read.

3.2 Improper use

Do not use balance for dynamic weighing. In the event that small quantities are removed or added to the material to be weighed, incorrect weighing results can be displayed due to the “stability compensation” in the balance. (Example: Slowly draining fluids from a container on the balance.)

Do not leave permanent load on the weighing plate. This may damage the measuring system.

Impacts and overloading exceeding the stated maximum load (max) of the balance, minus a possibly existing tare load, must be strictly avoided. Balance may be damaged by this.

Never operate balance in explosive environment. The serial version is not explosion protected.

The structure of the balance may not be modified. This may lead to incorrect weighing results, safety-related faults and destruction of the balance.

The balance may only be used according to the described conditions. Other areas of use must be released by KERN in writing.

3.3 Warranty

Warranty claims shall be voided in case

- Our conditions in the operation manual are ignored
- The appliance is used outside the described uses
- The appliance is modified or opened
- Mechanical damage or damage by media, liquids, natural wear and tear
- The appliance is improperly set up or incorrectly electrically connected
- The measuring system is overloaded

3.4 Monitoring of Test Resources

In the framework of quality assurance the measuring-related properties of the balance and, if applicable, the testing weight, must be checked regularly. The responsible user must define a suitable interval as well as type and scope of this test. Information is available on KERN's home page (www.kern-sohn.com) with regard to the monitoring of balance test substances and the test weights required for this. In KERN's accredited DKD calibration laboratory test weights and balances may be calibrated (return to the national standard) fast and at moderate cost.

4 Basic Safety Precautions

4.1 Pay attention to the instructions off the Operation Manual



Carefully read this operation manual before setup and commissioning, even if you are already familiar with KERN balances.

Versions in other languages are non-binding translations.
The only binding version is the original document in German.

4.2 Personnel training

The appliance may only be operated and maintained by trained personnel.

5 Transportation & Storage

5.1 Testing upon acceptance

When receiving the appliance, please check packaging immediately, and the appliance itself when unpacking for possible visible damage.

5.2 Packaging / return transport



- ⇒ Keep all parts of the original packaging for a possibly required return.
- ⇒ Only use original packaging for returning.
- ⇒ Prior to dispatch disconnect all cables and remove loose/mobile parts.
- ⇒ Reattach possibly supplied transport securing devices.
- ⇒ Secure all parts such as glass wind screen, weighing platform, power unit etc. against shifting and damage.

6 Unpacking, Setup and Commissioning

6.1 Installation Site, Location of Use

The balances are designed in a way that reliable weighing results are achieved in common conditions of use.

You will work accurately and fast, if you select the right location for your balance.

Therefore, observe the following for the installation site:

- Place scales on a stable, even surface;
- Avoid extreme heat as well as temperature fluctuation caused by installing next to a radiator or in the direct sunlight;
- Protect the balance against direct draughts due to open windows and doors;
- Avoid jarring during weighing;
- Protect the balance against high humidity, vapors and dust;
- Do not expose the device to extreme dampness for longer periods of time. Non-permitted condensation (condensation of air humidity on the appliance) may occur if a cold appliance is taken to a considerably warmer environment. In this case, acclimatize the disconnected appliance for ca. 2 hours at room temperature.
- Avoid static charge of goods to be weighed or weighing container.

Major display deviations (incorrect weighing results) may be experienced should electromagnetic fields (e.g. due to mobile phones or radio equipment), static electricity accumulations or instable power supply occur. Change location or remove source of interference.

6.2 Unpacking and implantation

Carefully remove the balance from the packaging, remove plastic cover and setup balance at the intended workstation.

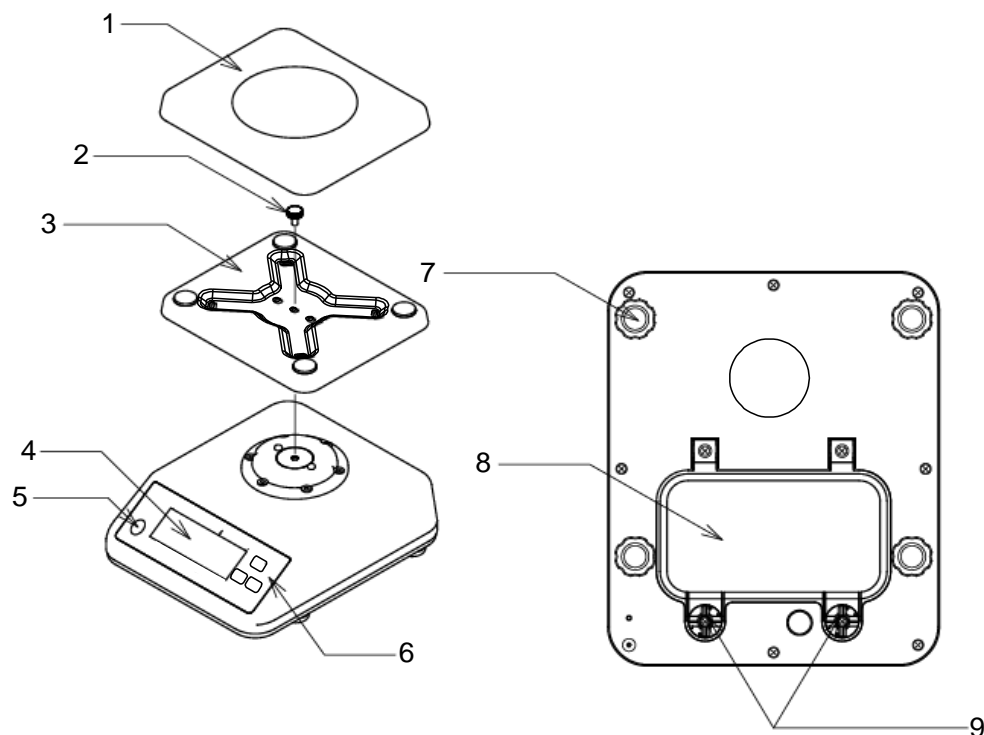

- 1 Weighing plate
- 2 Locking screw
- 3 Carrier weighing plate
- 4 Display
- 5 Bubble level
- 6 Keyboard
- 7 Footscrews
- 8 Rechargeable battery compartment cover
- 9 Screws of battery compartment cover



Level balance with foot screws until the air bubble of the water balance is in the prescribed circle.

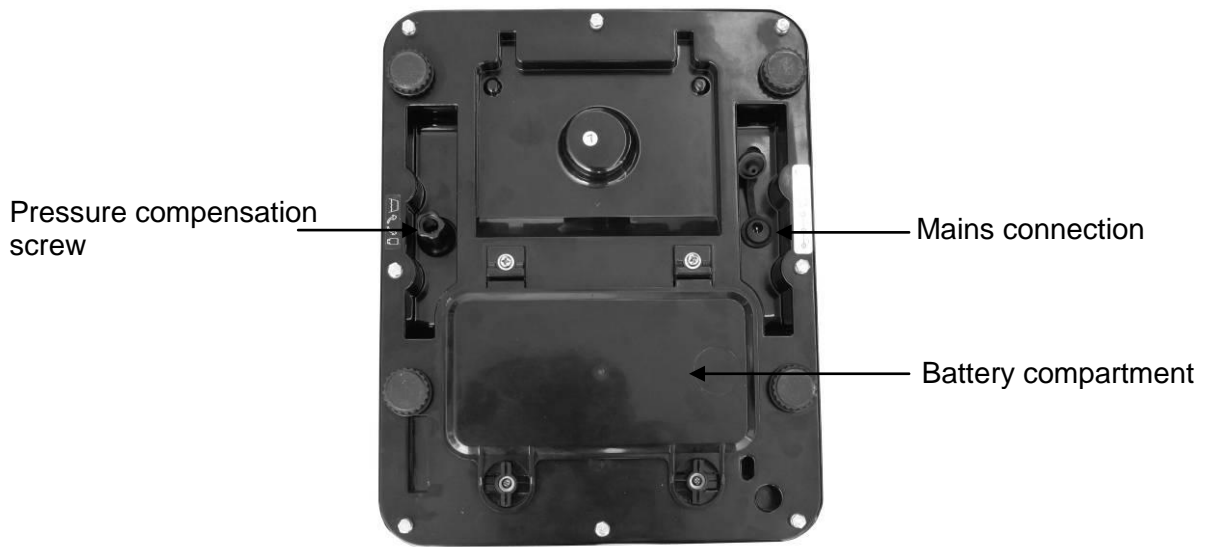
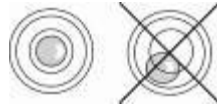

Pressure compensation screw:

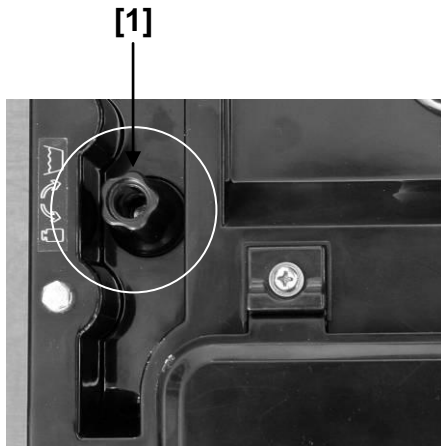

i On the lower side of the balance there is a pressure compensation screw [1] which has to be opened for the weighing process. Fasten the screw before cleaning the balance.



Membrane for degree of protection IP65

6.2.1 Scope of supply

Serial accessories:

- Balance
- Weighing plate
- Carrier weighing plate
- Fastening screw of the carrier weighing plate
- Operating instructions
- Rechargeable battery
- Hexagonal socket wrench

6.3 Battery power supply

The rechargeable battery is charged via the delivered power supply.

The operating time of the rechargeable battery with background illumination is 30h, without that it is 50 hrs. Charging time until complete recharging 12h.

In the menu you can activate the AUTO-OFF function [time off], see chap. 9.3.

According to menu settings, the balance switches automatically off in order to spare the battery.

Insert rechargeable battery:



⇒ Remove any adherent moisture from the balance

⇒ Move both levers 90° to the left

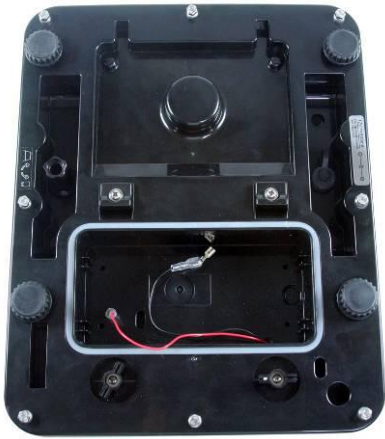

⇒ Remove the rechargeable battery cover



⇒ Connecting the rechargeable battery



Watch the colours:

Red on red !

Black on black!

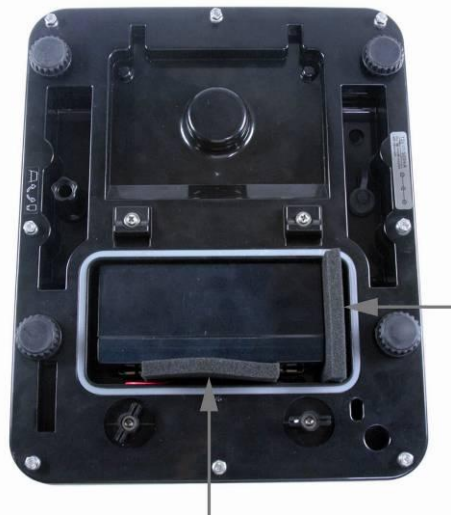

⇒ Insert the rechargeable battery in a manner that it cannot slip (fasten with a rubber mat)



Ensure that the cables are not squeezed.



- ⇒ Close the rechargeable battery cover
- ⇒ Move both levers 90° to the right

If in the display the triangle ▼ appears above the capacity display , the rechargeable battery is nearly exhausted. Connect power pack, the rechargeable battery is loaded.



Avoid excess pressure on the balance in order to avoid damaging them, particularly as they are supported by the weighing plate.

6.3.1 Mains connection during rechargeable battery operation



During the rechargeable battery operation ensure that the mains connection is covered with a rubber cap.

Only by this the type of protection IP65 is ensured.



6.4 Initial Commissioning

In order to obtain exact results with the electronic balances, your balance must have reached the operating temperature (see warming up time chap. 1).

The weighing scale must be connected to the power supply (batteries) during this warm-up time.

The accuracy of the balance depends on the local acceleration of gravity.

Strictly observe hints in chapter Adjustment.

6.5 Protection type IP65

Designed for temporary contact with liquids. Use a damp cloth for cleaning.

Dustproof.

7 Adjustment

As the acceleration value due to gravity is not the same at every location on earth, each balance must be coordinated - in compliance with the underlying physical weighing principle - to the existing acceleration due to gravity at its place of location (only if the balance has not already been adjusted to the location in the factory).

This adjustment process must be carried out for the first commissioning, after each change of location as well as in case of fluctuating environment temperature. To receive accurate measuring values it is also recommended to adjust the balance periodically in weighing operation.

7.1 Adjustment

Carry out adjustment as near as possible to the maximum load of the scale (See chpt. 1 "Techn. data"). The accuracy of the weight used for adjustment has to correspond approximately to readability **d** of the scale, or rather closer than that. Info about test weights can be found on the Internet at: <http://www.kern-sohn.com>

Procedure when adjusting:

Observe stable environmental conditions. A warming up time (see chapter 1) is required for stabilization.

7.1.1 Adjusting non-verifiable models

Display

Operation

- ⇒ Start balance by pressing
- ⇒ Whilst the weighing scale is carrying out a self-test, (00...- 99...) press and hold until the message "F1 CAL" appears.

- ⇒ Press , in the display appears „UnLod“.

(Example)

- ⇒ Press again the weight value will be displayed.

- ⇒ Enter value for adjustment weight (See chpt 1) by
- ⇒ Position weight

- ⇒ Press Remove weight whilst scale is carrying out self-test Weighing scale changes to zero display. This completes the adjustment process.

7.1.2 Adjusting verifiable models

i The adjustment is locked for verified balances.
with adjustment switch

To disable the access lock, destroy the seal and actuate the adjustment switch. Position of the adjustment switch see chapter 7.2.1



Attention:

After destruction of the seal the balance must be re-verified by an authorised agency and a new verification wire/seal mark fitted before it can be reused for applications subject to verification.

Display



Operation

- ⇒ Start balance by pressing 
- ⇒ While the balance carries out a self test (00...- 99...), press  and keep pressed until „F1 CAL“ appears on the display.
- ⇒ Actuate the adjustment switch on the lower side of the balance

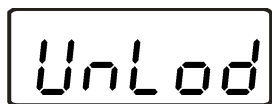

- ⇒ Press  in the display appears „UnLod“.

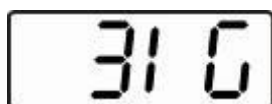

(Beispiel)

- ⇒ Press  anew
The weighing value is displayed.



- ⇒ Press  to enter the value of the adjustment weight (see chapter 1)

- ⇒ Place the adjustment weight



- ⇒ Press  While the balance carries out a self-test, take away the adjustment weight



The balance changes over to zero display.
Now the process of adjustment is completed.

7.2 Verification

General introduction:

According to EU directive 90/384/EEC or 2009/23EG balances must be officially verified if they are used as follows (legally controlled area):

- a) For commercial transactions if the price of goods is determined by weighing.
- b) For the production of medicines in pharmacies as well as for analyses in the medical and pharmaceutical laboratory.
- c) For official purposes
- d) For manufacturing final packages

In cases of doubt, please contact your local trade in standard.

Verification notes:

An EU type approval exists for balances described in their technical data as verifiable. If a balance is used where obligation to verify exists as described above, it must be verified and re-verified at regular intervals.

Re-verification of a balance is carried out according to the respective national regulations. The validity for verification of balances in Germany is e.g. 2 years.

The legal regulation of the country where the balance is used must be observed!



Verification of the balance is invalid without the seal.

The seal marks attached on verified balances point out that the balance may only be opened and serviced by trained and authorised specialist staff. If the seal mark is destroyed, verification loses its validity. Please observe all national laws and legal regulations. In Germany a re-verification will be necessary.

7.2.1 Adjustment switch and seals

After a verification the balance is sealed at the indicated positions.

Position of the official seals:

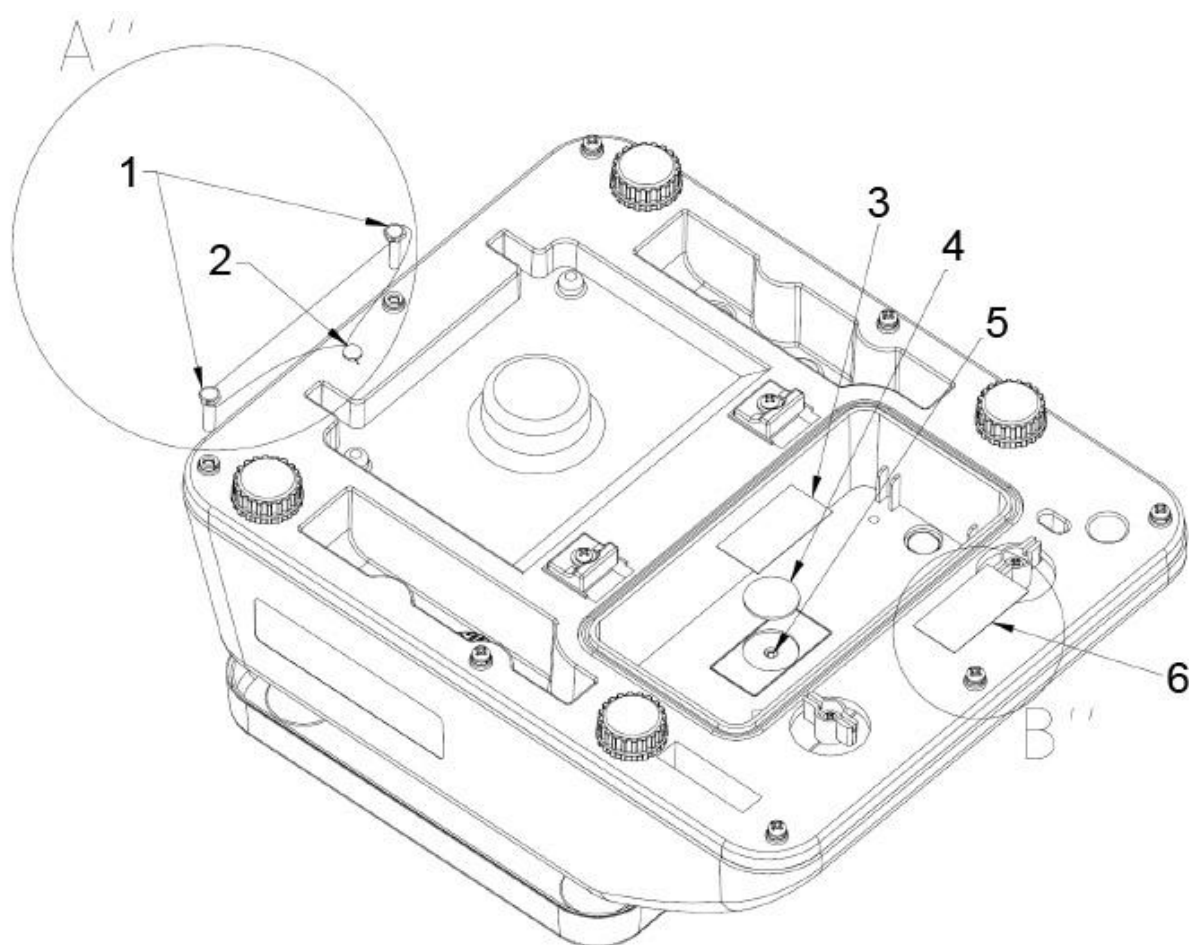

1. Verification wire fastening
2. Verification wire fastening
3. Self-destroying seal mark
4. Cover of adjustment switch
5. Adjustment switch
6. Self-destroying seal mark

8 Operation

8.1 Weighing



Start balance by pressing



Program version is displayed.

Afterwards the balance will carry out a self-test.

The balance will be ready for operation as soon as weight reading "0.0" and the triangular icon ▼ above the stability display ▲▲ appear.



- The  key can be used to set the balance to zero at any time.



Turn off scale by pressing



The "0.0" display disappears and the weighing scale is now switched off.

8.2 Taring

The tare weight of any preloads can be deducted by pressing a button so that the actual weight of the baby is displayed in subsequent weighings.



Put on weighing receptacles and press



The zero display appears as well as the triangle ▼ above the zero setting icon →0← as well as the stability icon ▲▲ and the net weight icon **NET**.

The weight of the container is now internally saved.



Place goods to be weighed in the weighing container.

The **net weight** of the goods to be weighed is displayed.



The weight of the weighing container will be displayed as a minus number after removing the weighing container (= gross weight).





The tare weight is saved until it is deleted. Remove the load from the balance and press . The zero display appears and the triangle ▼ above the net weight icon **NET** disappears.



Gross weight:



- ⇒ Press  as long as the weighing tray and the load are present on the weighing platform.
- ⇒ Remove weighing goods and receptacle
Gross weight will be shown as a negative value.

8.3 Weighing units switch-over

- ⇒ Press  and  at the same time.
The weighing scale switches between the kg and lb units. (for not verifiable devices) or kg and g (in verifiable devices).

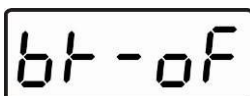
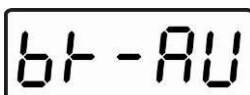
8.4 Background illumination



- ⇒ Press  for approx. 3 seconds, „bK-AU“ will be displayed.
- ⇒ Press  to select background illumination automatically off („bK-AU“) and background illumination off („bK-oF“).
- ⇒ Press  to confirm selected setting.

The balance changes into weighing mode

9 The menu

9.1 Navigation in the menu



⇒ Start balance by pressing



⇒ While the balance carries out a self test, press  and keep pressed until „F1 CAL“ appears







⇒ Use  to change to the next menu item

⇒ Select menu item using 

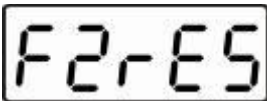
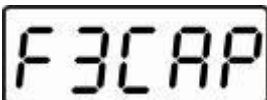
⇒ Use  to change between the individual parameters

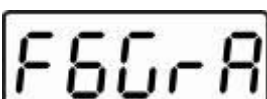
⇒ Select the desired parameter using 

9.2 Menu overview

Menu item	Function
	Calibrate
	not documented
	not documented
	not documented
	Auto-OFF function, adjustable between off, 3, 5 and 15 minutes
	not documented
	Multi-Tare function: 0 tare Multi-Tare function disabled P tare Multi-Tare function enabled
	not documented
	Return to weighing mode

9.3 Set auto-OFF function

U 1.0 x

⇒ Start balance by pressing 



F 1 CAL

⇒ While the balance carries out a self test, press  and keep pressed until „F1 CAL“ appears

F5 oFF

⇒ Press  repeatedly until „F5 oFF“ appears



oFF

⇒ Select function using 

⇒ Use  to change between the individual parameters



3nin

⇒ Select the desired parameter using 



5nin



15nin



F5 oFF

“F5 oFF“ appears, now the function is enabled

bACK

⇒ Press  repeatedly until “bACK“ appears

⇒ Press 
The balance carries out a restart and changes to weighing mode

9.4 Setting the Multi-Tare function

U 1.0 x

⇒ Start balance by pressing 



F 1 CAL

⇒ While the balance carries out a self test, press  and keep pressed until „F1 CAL“ appears

F8 t n

⇒ Press  repeatedly until „F8 tn“ appears



⇒ **For verifiable devices press the adjustment switch**

0tArE

⇒ Select function using , the function adjusted as last will be displayed (PtArE or 0tArE)



⇒ Use  to change between the individual parameters

PtArE

⇒ Use  to select „PtArE“



F8 t n

“F8 tn“ appears, now the function is enabled





bACK

⇒ Press  repeatedly until “bACK“ appears

⇒ Press 
The balance carries out a restart and changes to weighing mode

Now you have the ability to tare several times in a row.

10 Error messages

Display	Description	Remedy
	Zero range exceeded	Unload the balance
	A/D converter outside range	Unload the balance; check if the weighing is correctly placed and screwed on
	Displayed weight is permanently changing	Avoid air draughts / air movement as well as vibrations of the table and of the floor
	Overload	Unload the balance and adjust again

11 Instant Help

In case of an error in the program process, briefly turn off the balance and disconnect from power supply. The weighing process must then be restarted from the beginning.

Fault

Possible cause

The displayed weight does not glow.

- The balance is not switched on.
- Batteries are inserted incorrectly or empty
- No batteries inserted.

The displayed weight is permanently changing

- Draught/air movement
- Table/floor vibrations
- Weighing plate has contact with other objects.
- Electromagnetic fields / static charging (choose different location/switch off interfering device if possible)

The weighing value is obviously wrong

- The display of the balance is not at zero
- Adjustment is no longer correct.
- Great fluctuations in temperature.
- The balance is on an uneven surface.
- Electromagnetic fields / static charging (choose different location/switch off interfering device if possible)

Should other error messages occur, switch balance off and then on again. If the error message remains inform manufacturer.

12 Service, maintenance, disposal

12.1 Cleaning

Remove batteries from instrument before cleaning.

Please do not use aggressive cleaning agents (solvents or similar agents), but a cloth dampened with mild soap suds. Ensure that no liquid penetrates into the device and wipe with a dry soft cloth.

Loose residue sample/powder can be removed carefully with a brush or manual vacuum cleaner.

Spilled weighing goods must be removed immediately.

12.2 Service, maintenance

The appliance may only be opened by trained service technicians who are authorized by KERN.

Before opening, disconnect from power supply.

12.3 Disposal

Disposal of packaging and appliance must be carried out by operator according to valid national or regional law of the location where the appliance is used.